

# 310 Validate CoS Reading

Message

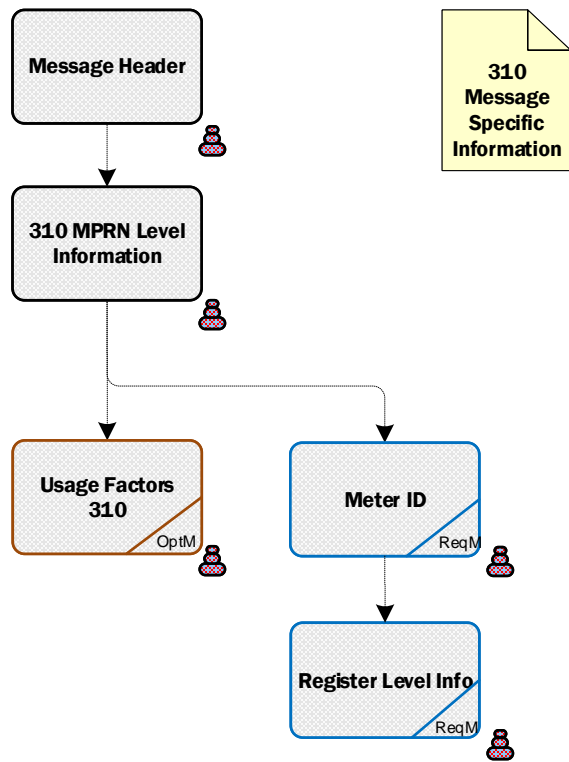

## 310 Validate CoS Reading

310 Valid Codes
<b>Meter Point Status</b>
D – De-energised
E – Energised
<b>Read Reason</b>
26 – Change of Supplier
<b>Read Type</b>
A – An actual reading obtained by ESB Networks
E – An estimate due to no-access or a missing register reading
EF – An estimate due to an implausible reading / No read available
RC – A replacement reading or estimate agreed for use by both Suppliers
CU – A reading provided directly by a customer
SC – A customer reading provided by a Supplier
EP – An estimate due to a planned no-visit
EU – An estimate due to an unplanned no-visit
<b>Read Status</b>
RV Reading which is plausible / valid
RREL Reading was originally implausible but released on investigation as plausible
REST Reading was estimated and usage factors deriving from estimate will be used in Settlement. See Read Type for reason for estimate.

# 310 Validate CoS Reading

Segment

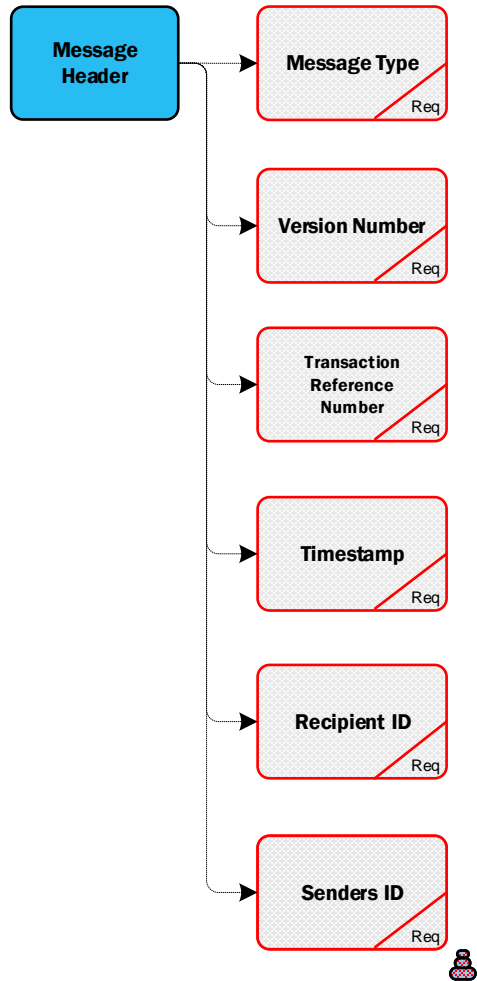

Message

Message Header

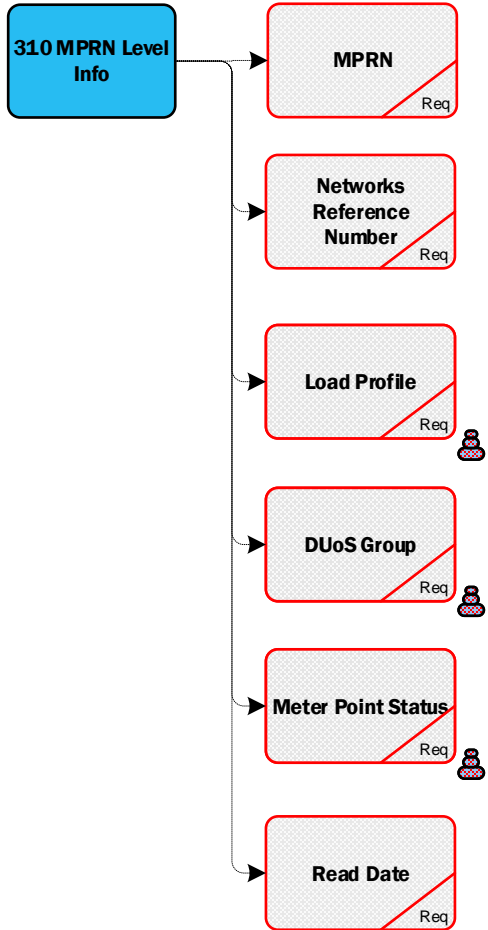

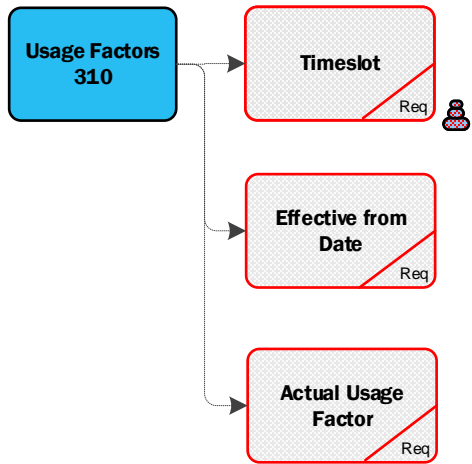

# 310 Validate CoS Reading

Segment

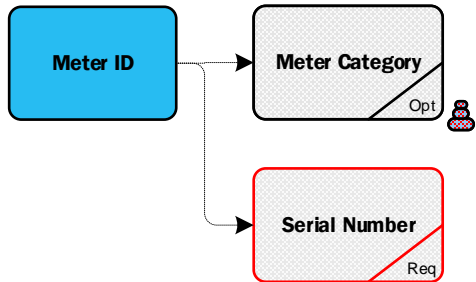

Message

Meter ID

### Register Level Information

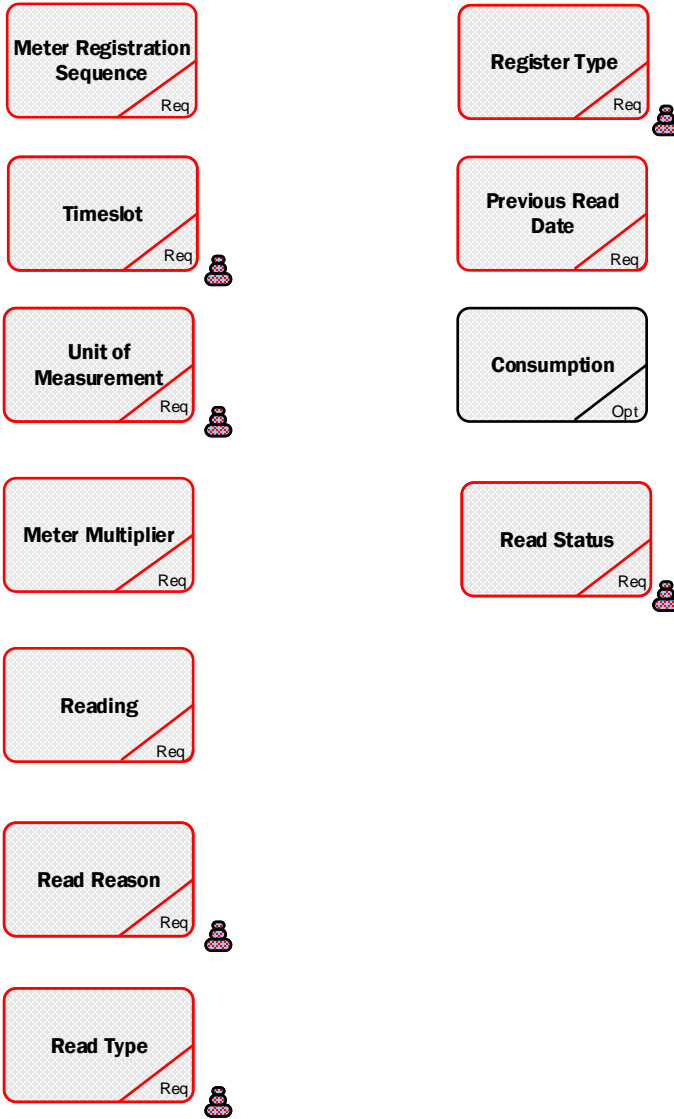

**Senders  
ID**

**Click Here for Latest  
Senders ID  
List**



# 310 Validate CoS Reading

Code

Load Profile

01 - Urban Domestic Unrestricted

10 - Unmetered - Flat

02 - Urban Domestic Day/Night

11 - Public Lighting Dusk/Dawn

03 - Rural Domestic Unrestricted

12 - Public Lighting Dusk/Midnight

04 - Rural Domestic Day/Night

25 - Urban domestic SST

05 - Non Domestic Unrestricted

27 - Rural domestic SST

06 - Non Domestic Day/Night

29 - Non-domestic SST

07 - MD with LF up to (but not including) 30%

08 - MD with LF greater than or equal to 30% but less than 50%

09 - MD with LF greater than or equal to 50%

Message

MPRN Level Information

**RMDS** RETAIL MARKET DESIGN SERVICE

Load Profile

## 310 Validate CoS Reading

Code

DUoS Group

AGU	DG1	Urban Domestic	DG7	MV MD
AMM	DG10	Yes	DG7A	MV MD Autoproducer
CAN	DG2	Rural Domestic	DG7B	MV MD Importing Autoproducer or CHP Producer
CIP	DG3	Public Lighting	DG8	38 kV Looped MD
COL	DG4	Unmetered Supplies	DG8A	38 kV Looped MD Autoproducer
COS	DG5	LV Non-Domestic Non-MD	DG8B	38 kV Looped MD Importing Autoproducer or CHP Producer
CUG	DG5A	LV Non-Domestic Non-MD Autoproducer	DG9	38 kV Tailed MD
DIJ	DG5B	LV Non-Domestic Non-MD Importing Autoproducer or CHP Producer	DG9A	38 kV Tailed MD Autoproducer
DSO	DG6	LV MD	DG9B	38 kV Tailed MD Importing Autoproducer or CHP Producer
IA	DG6A	LV MD Autoproducer	DG10	110kV Distribution
ICD	DG6B	LV MD Importing Autoproducer or CHP Producer	TCON	Transmission Connected

Message

MPRN Level Information

**RMDS** RETAIL MARKET DESIGN SERVICE

DUoS Group

# 310 Validate CoS Reading

Code

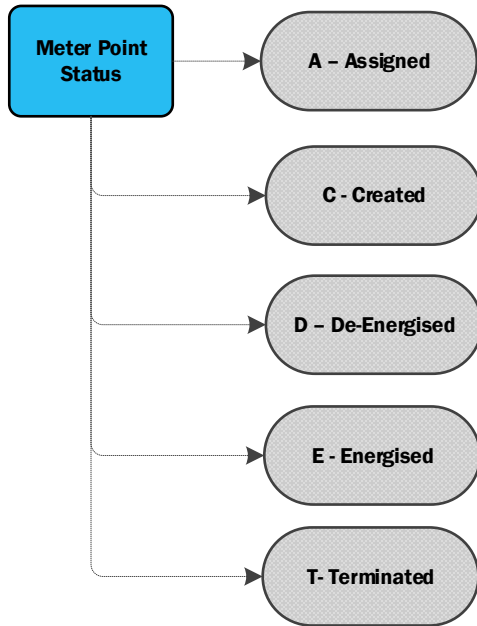

Message

MPRN Level Information

**RMDS** RETAIL MARKET DESIGN SERVICE

Meter Point Status

# 310 Validate CoS Reading

Code

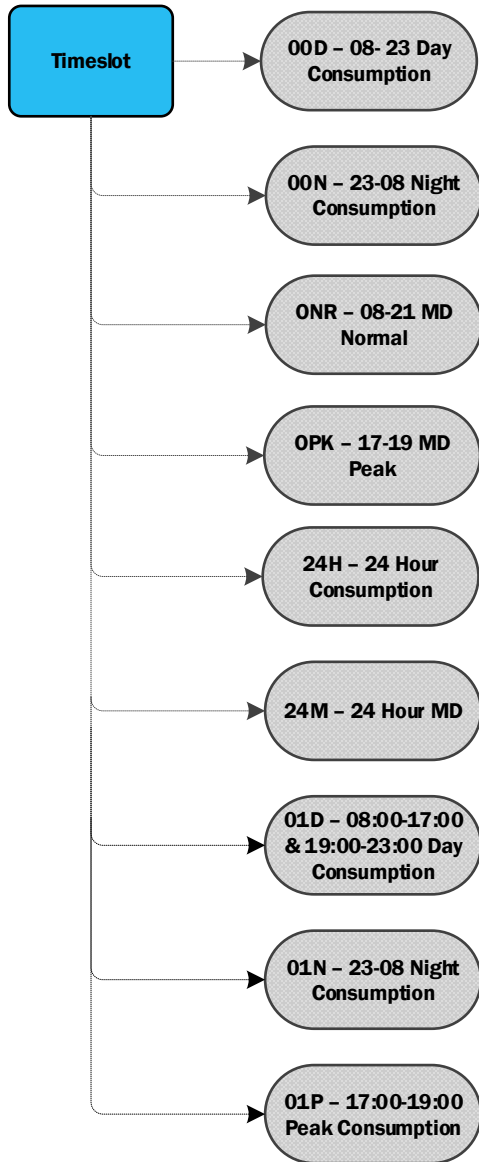

**Meter Category**

**Click Here for Latest  
Meter Category  
List**

# 310 Validate CoS Reading

Code

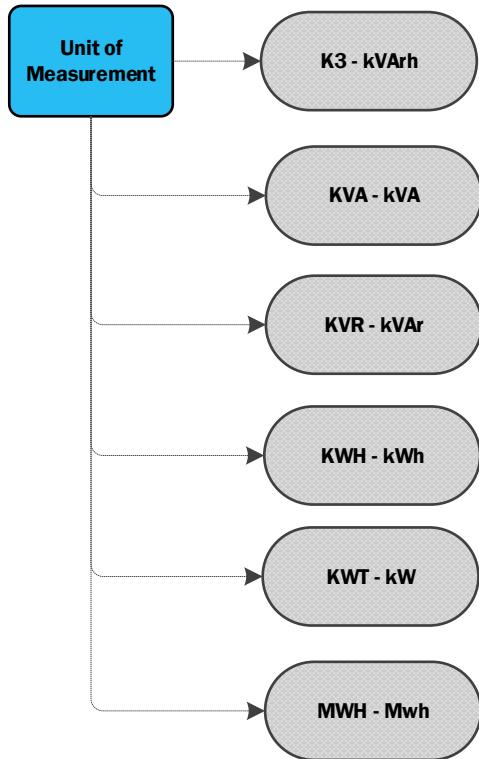

# 310 Validate CoS Reading

Code

Read Reason

01 - Scheduled

17 - Change of Profile

95 - Not for CoS

02 - Special Read, Chargeable

18 - Energisation

04 - Special Read to resolve dispute

21 - Start Reading ( New Register)

09 - Special Read, non chargeable

22 - Closing Reading (Register removed)

10 - Ad-hoc, no chargeable check read

23 - Meter Works Single reading

11 - Start reading after meter re-programming

26 - Change of Supplier

13 - De-Energisation

27 - Change of Legal Entity

14 - Estimate

28 - Closing read before register re-number

16 - Closing read before meter re-programming

29 - Star read after register re-number

Message

Register Level Info

RMDS

RETAIL MARKET DESIGN SERVICE

Read Reason

# 310 Validate CoS Reading

Code

Read Type

A - Actual

SU - Substitute  
(Interval)

CU - Customer  
Reading

E - Estimate (No  
Access)

ED - Estimate (DUoS  
Billing has occurred)

EF - Estimate  
(Implausible/ No  
Read available)

EP - Estimate (Block  
Planned)

EU - Estimate (Block  
Unplanned)

RC - Replacement  
Read

SC - Supplier  
Provided Customer  
Reading

Message

Register Level Info

RMDS

RETAIL MARKET DESIGN SERVICE

Read Type



# 310 Validate CoS Reading

Code

Register Type

01 - 24hr

50 - IMP QH (KW)

02 - Day

51 - IMP QH (kVAr)

03 - Night

52 - EXP QH(KW)

04 - NSH

53 - EXP QH (kVAr)

05 - Wattless

70 - Import HH kW

06 - MD Normal

74 - Import 24hr kWh

07 - MD Peak

78 - Day Off Peak

08 - Cumulative MD Normal

79 - Night Off Peak

09 - Cumulative MD Peak

80 - Peak

Message

Register Level Info

RMDS

RETAIL MARKET DESIGN SERVICE

Register Type

# 310 Validate CoS Reading

Code

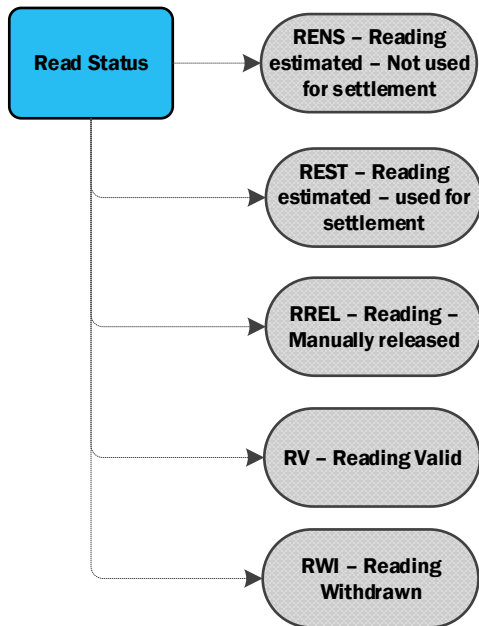

## 310 Validate CoS Reading

Version Which Implemented	Source of Change	Description of Change
10.4	MCR 1155	Message format changed from ARIS to Document format.
10.6	CoBLCR 008 & CoBLCR 011	Meter Category – Removed table & replaced with link to Meter Category page on RMDS Website
13.0	MCR1159	New Codes added for Load Profile, Timeslot and Register Type.