

# 307W Meter Point Status Change Energisation Withdrawn Read

Message

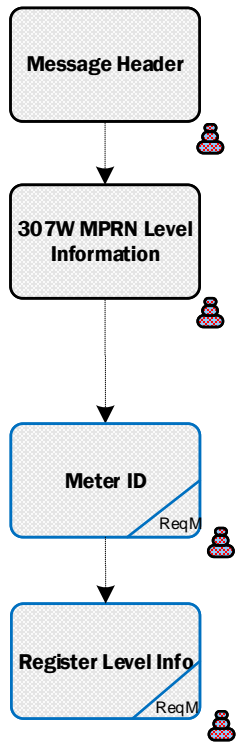

307W  
Message  
Specific  
Information

## 307W Meter Point Status Change Energisation Withdrawn Read

<b>307W Valid Codes</b>
<b>Meter Point Status</b>
This will always be set to E – Energised on this message.
<b>Read Reason</b>
18 - Energise only
<b>Read Type</b>
A Actual
<b>Read Status</b>
RWI - Reading withdrawn
<b>Register Type</b>
01 24Hr
02 Day
03 Night
04 NSH
05 Wattless
06 MD Normal
07 MD Peak
08 Cumulative MD Normal
09 Cumulative MD Peak

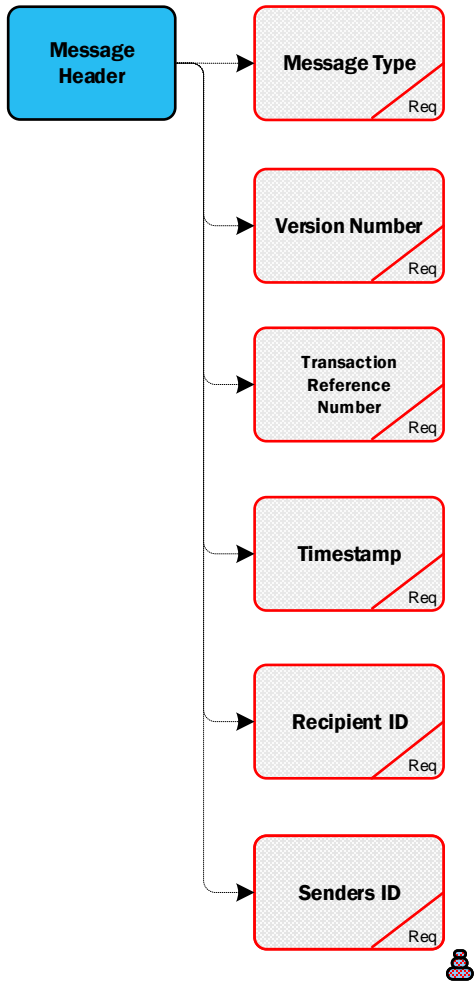

**307W MPRN  
Level Info**

**MPRN**  
Req

**Withdrawal Reason**  
Req

**Market Participant  
Business  
Reference**  
Opt

**Essential Plant  
Flag**  
Opt

**Networks  
Reference  
Number**  
Req

**Load Profile**  
Req

**DUoS Group**  
Req

**Meter Point Status**  
Req

**Effective From  
Date**  
Req

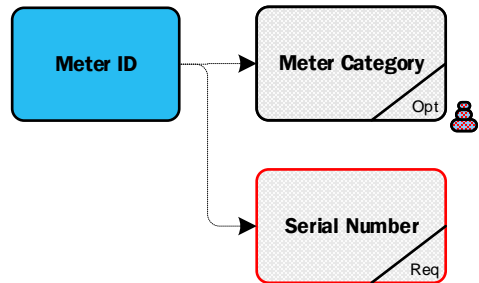

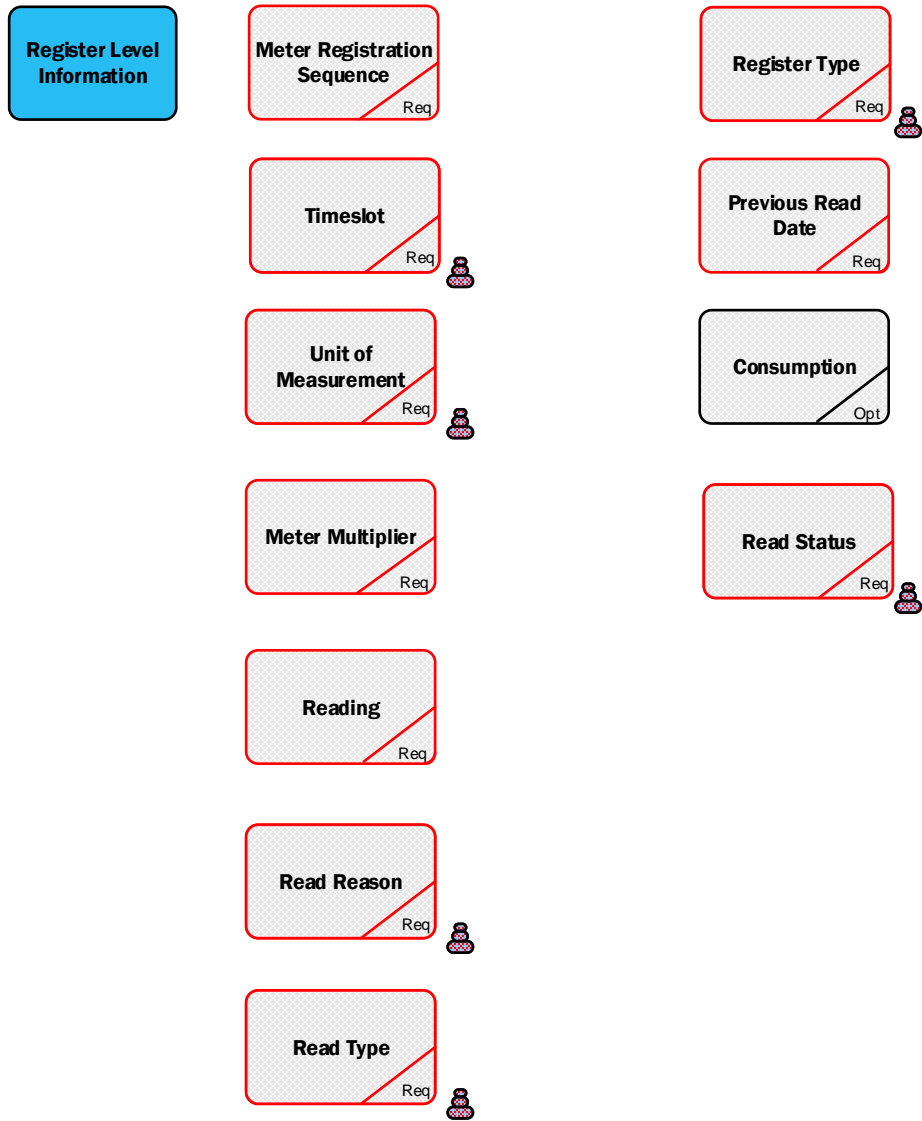

**Senders  
ID**

**Click Here for Latest  
Senders ID  
List**

# 307W Meter Point Status Change Energisation Withdrawn Read

Code

Load Profile

01 - Urban Domestic Unrestricted

10 - Unmetered - Flat

02 - Urban Domestic Day/Night

11 - Public Lighting Dusk/Dawn

03 - Rural Domestic Unrestricted

12 - Public Lighting Dusk/Midnight

04 - Rural Domestic Day/Night

25 - Urban domestic SST

05 - Non Domestic Unrestricted

27 - Rural domestic SST

06 - Non Domestic Day/Night

29 - Non-domestic SST

07 - MD with LF up to (but not including) 30%

08 - MD with LF greater than or equal to 30% but less than 50%

09 - MD with LF greater than or equal to 50%

Message

MPRN Level Information

RMDS

RETAIL MARKET DESIGN SERVICE

Load Profile



# 307W Meter Point Status Change Energisation Withdrawn Read

Code

DUoS Group

AGU	DG1	Urban Domestic	DG7	MV MD
AMM	DG10	Yes	DG7A	MV MD Autoproducer
CAN	DG2	Rural Domestic	DG7B	MV MD Importing Autoproducer or CHP Producer
CIP	DG3	Public Lighting	DG8	38 kV Looped MD
COL	DG4	Unmetered Supplies	DG8A	38 kV Looped MD Autoproducer
COS	DG5	LV Non-Domestic Non-MD	DG8B	38 kV Looped MD Importing Autoproducer or CHP Producer
CUG	DG5A	LV Non-Domestic Non-MD Autoproducer	DG9	38 kV Tailed MD
DIJ	DG5B	LV Non-Domestic Non-MD Importing Autoproducer or CHP Producer	DG9A	38 kV Tailed MD Autoproducer
DSO	DG6	LV MD	DG9B	38 kV Tailed MD Importing Autoproducer or CHP Producer
IA	DG6A	LV MD Autoproducer	DG10	110kV Distribution
ICD	DG6B	LV MD Importing Autoproducer or CHP Producer	TCON	Transmission Connected

Message

MPRN Level Information

**RMDS**

RETAIL MARKET DESIGN SERVICE

DUoS Group

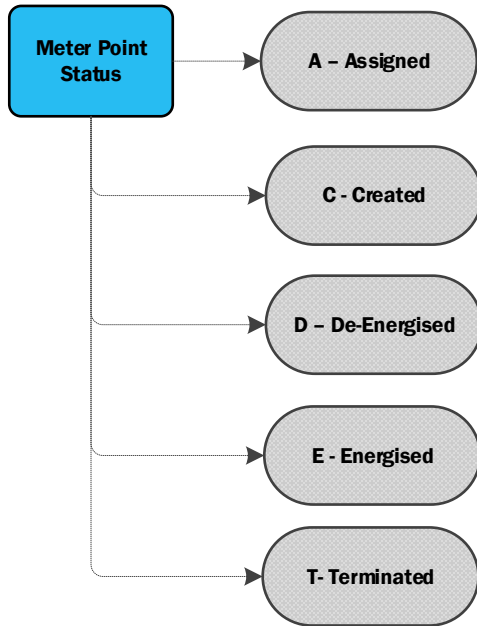

# 307W Meter Point Status Change Energisation Withdrawn Read

Code

Withdrawal Reason

A1 - Erroneous Change of Supplier

D2 - Incorrect Billing Period

A2 - Disputed Cos Meter Reading

D3 - Incorrect Meter

A3 - Change of Supplier Cancellation

A4 - Change of Supplier

A5 - Change of Legal Entity

B1 - Incorrect MPRN

C1 - Incorrect Estimation

C2 - Incorrect Meter Reading

D1 - Incorrect Rate

Message

MPRN Level Information

RMDS

RETAIL MARKET DESIGN SERVICE

Withdrawal Reason

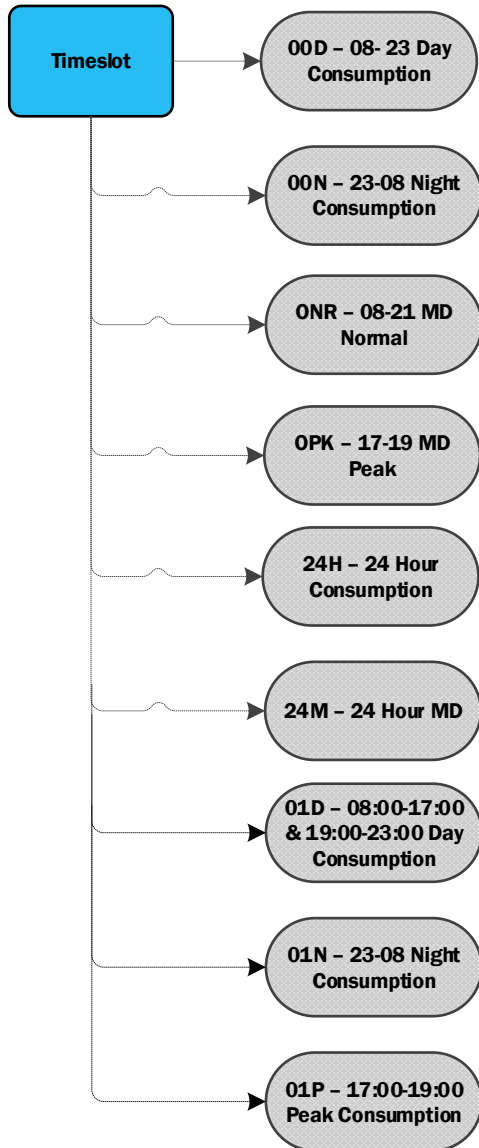

**Meter Category**

**Click Here for Latest  
Meter Category  
List**

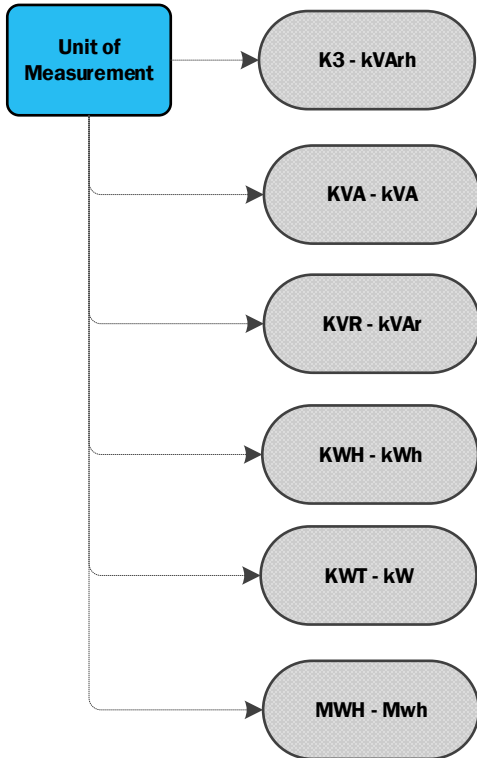

# 307W Meter Point Status Change Energisation Withdrawn Read

Code

Read Reason

01 - Scheduled

17 - Change of Profile

95 - Not for CoS

02 - Special Read, Chargeable

18 - Energisation

04 - Special Read to resolve dispute

21 - Start Reading ( New Register)

09 - Special Read, non chargeable

22 - Closing Reading (Register removed)

10 - Ad-hoc, no chargeable check read

23 - Meter Works Single reading

11 - Start reading after meter re-programming

26 - Change of Supplier

13 - De-Energisation

27 - Change of Legal Entity

14 - Estimate

28 - Closing read before register re-number

16 - Closing read before meter re-programming

29 - Star read after register re-number

Message

Register Level Info

RMDS

RETAIL MARKET DESIGN SERVICE

Read Reason

### Read Type

A - Actual

SU - Substitute  
(Interval)

CU - Customer  
Reading

E - Estimate (No  
Access)

ED - Estimate (DUoS  
Billing has occurred)

EF - Estimate  
(Implausible/ No  
Read available)

EP - Estimate (Block  
Planned)

EU - Estimate (Block  
Unplanned)

RC - Replacement  
Read

SC - Supplier  
Provided Customer  
Reading



# 307W Meter Point Status Change Energisation Withdrawn Read

Code

Register Type

01 - 24hr

50 - IMP QH (KW)

02 - Day

51 - IMP QH (kVAr)

03 - Night

52 - EXP QH(KW)

04 - NSH

53 - EXP QH (kVAr)

05 - Wattless

70 - Import HH kW

06 - MD Normal

74 - Import 24hr  
kWh

07 - MD Peak

78 - Day Off Peak

08 - Cumulative MD  
Normal

79 - Night Off Peak

09 - Cumulative MD  
Peak

80 - Peak

Message

Register Level Info

**RMDS**

RETAIL MARKET DESIGN SERVICE

Register Type

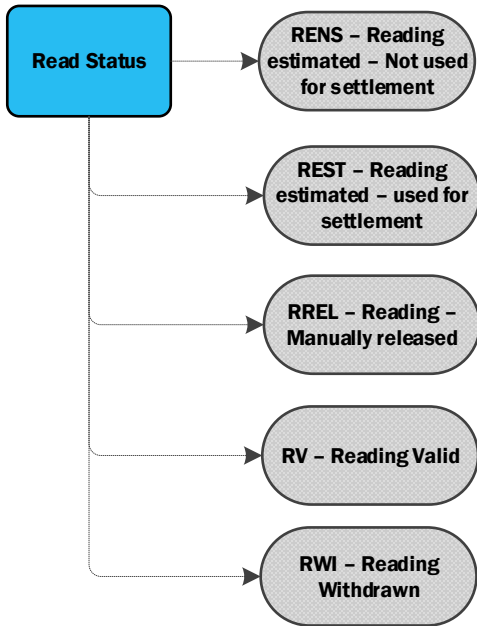

## 307W Meter Point Status Change Energisation Withdrawn Read

Version Which Implemented	Source of Change	Description of Change
10.4	MCR 1155	Message format changed from ARIS to Document format.
10.6	CoBLCR 008 & CoBLCR 011	Meter Category - Removed table & replaced with link to Meter Category page on RMDS Website
11.0	MCR 1122	New Data Item Essential Plant Flag added
13.0	MCR1159	New Codes added for Load Profile, Timeslot and Register Type.