

300W Withdrawn Non Interval Readings

Message

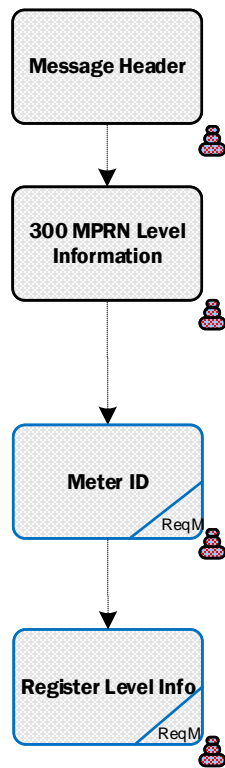

300W
Message
Specific
Information

300W Withdrawn Non Interval Readings

300W Valid Codes

Meter Point Status

E - Energised

D - De-energised

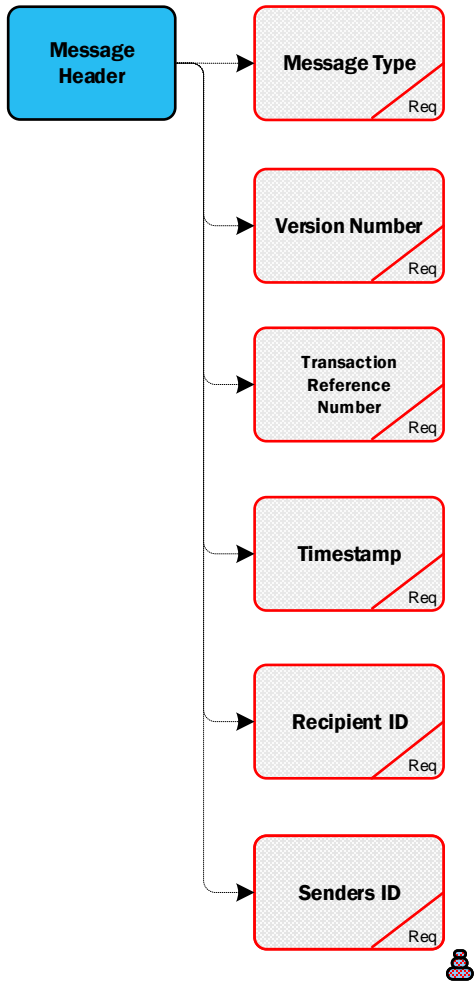

300W Withdrawn Non Interval Readings

Segment

**300W MPRN
Level Info**

MPRN
Req

**Withdrawal
Reason**
Req 

**Market Participant
Business
Reference**
Opt

**Networks
Reference
Number**
Req

Load Profile
Req 

DUoS Group
Req 

Meter Point Status
Req 

Read Date
Req

Message

300W Withdrawn Non Interval Readings

Segment

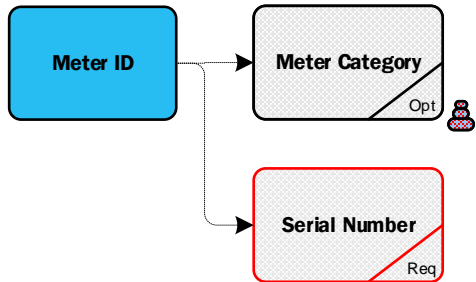

Message

Meter ID

Register Level Information

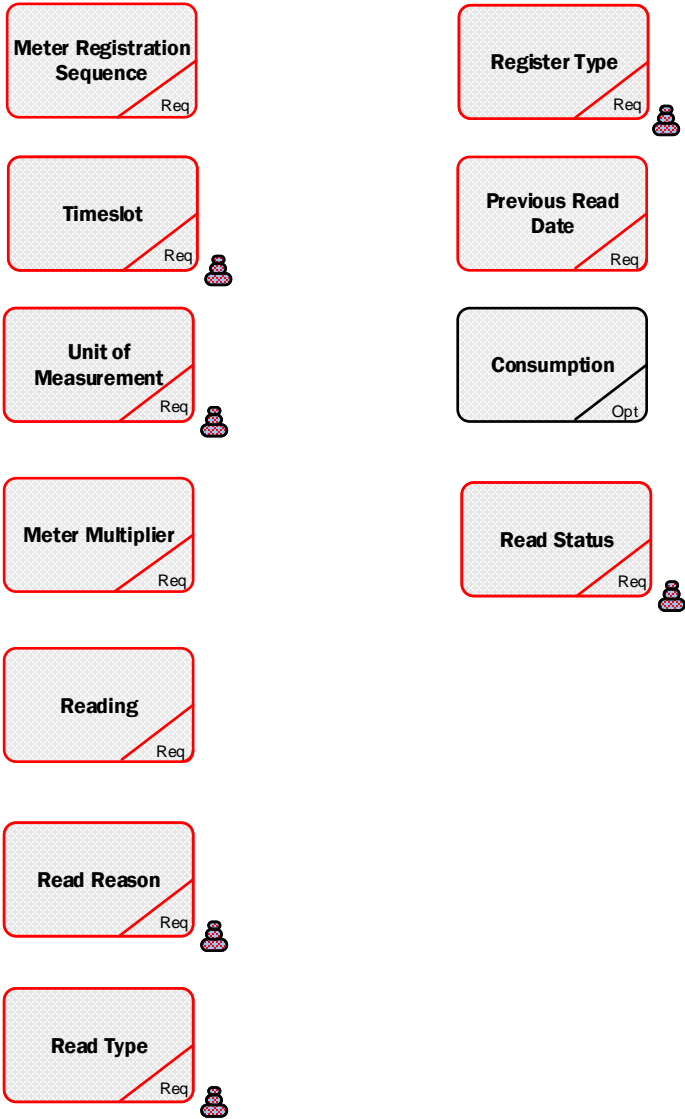

**Senders
ID**

**Click Here for Latest
Senders ID
List**

300W Withdrawn Non Interval Readings

Code

Load Profile

01 - Urban Domestic Unrestricted

10 - Unmetered - Flat

02 - Urban Domestic Day/Night

11 - Public Lighting Dusk/Dawn

03 - Rural Domestic Unrestricted

12 - Public Lighting Dusk/Midnight

04 - Rural Domestic Day/Night

25 - Urban domestic SST

05 - Non Domestic Unrestricted

27 - Rural domestic SST

06 - Non Domestic Day/Night

29 - Non-domestic SST

07 - MD with LF up to (but not including) 30%

08 - MD with LF greater than or equal to 30% but less than 50%

09 - MD with LF greater than or equal to 50%

Message

MPRN Level Information

Load Profile

300W Withdrawn Non Interval Readings

Code

DUoS Group

AGU	DG1	Urban Domestic	DG7	MV MD
AMM	DG10	Yes	DG7A	MV MD Autoproducer
CAN	DG2	Rural Domestic	DG7B	MV MD Importing Autoproducer or CHP Producer
CIP	DG3	Public Lighting	DG8	38 kV Looped MD
COL	DG4	Unmetered Supplies	DG8A	38 kV Looped MD Autoproducer
COS	DG5	LV Non-Domestic Non-MD	DG8B	38 kV Looped MD Importing Autoproducer or CHP Producer
CUG	DG5A	LV Non-Domestic Non-MD Autoproducer	DG9	38 kV Tailed MD
DIJ	DG5B	LV Non-Domestic Non-MD Importing Autoproducer or CHP Producer	DG9A	38 kV Tailed MD Autoproducer
DSO	DG6	LV MD	DG9B	38 kV Tailed MD Importing Autoproducer or CHP Producer
IA	DG6A	LV MD Autoproducer	DG10	110kV Distribution
ICD	DG6B	LV MD Importing Autoproducer or CHP Producer	TCON	Transmission Connected

Message

MPRN Level Information

RMDS RETAIL MARKET DESIGN SERVICE

DUoS Group

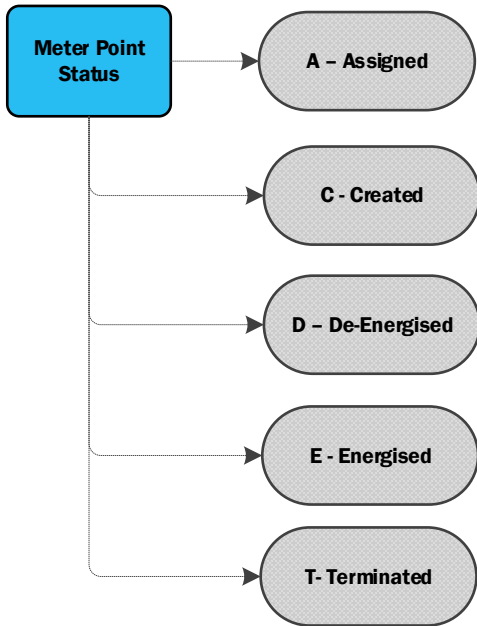

300W Withdrawn Non Interval Readings

Segment

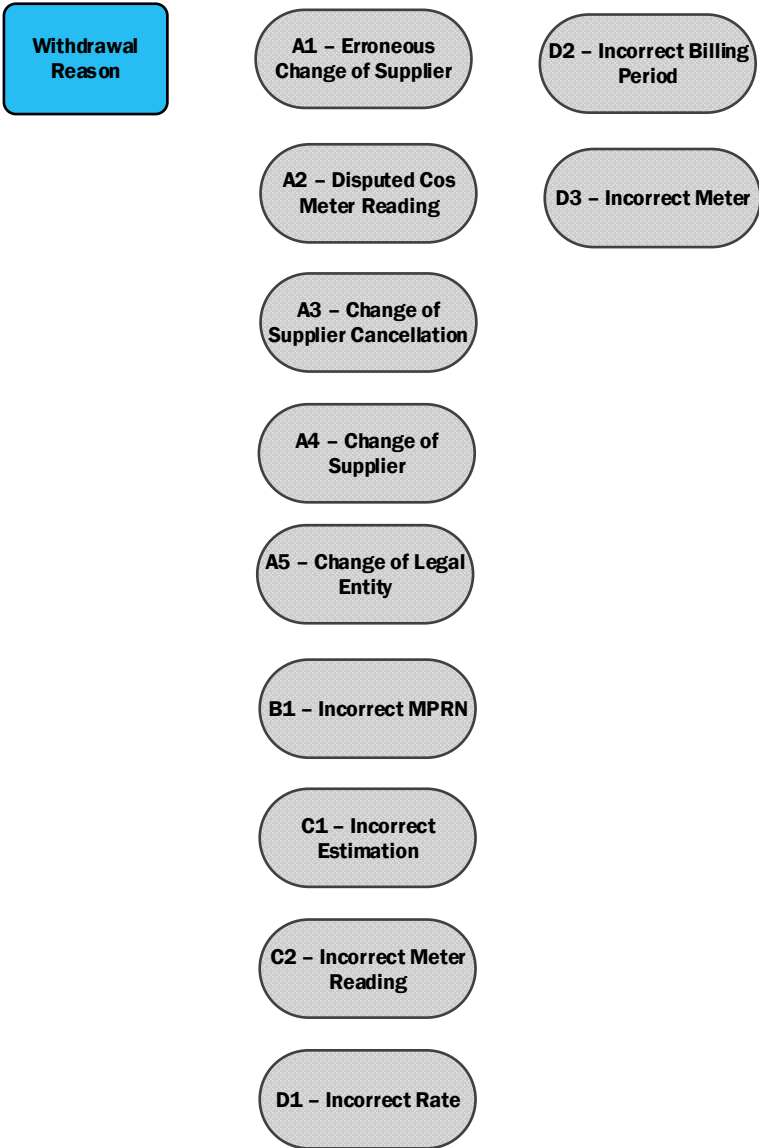

Message

MPRN Level Information

RMDS RETAIL MARKET DESIGN SERVICE

Withdrawal Reason

300W Withdrawn Non Interval Readings

Code

Meter Category

[Click Here for Latest
Meter Category
List](#)

Message

Meter ID

Meter Category

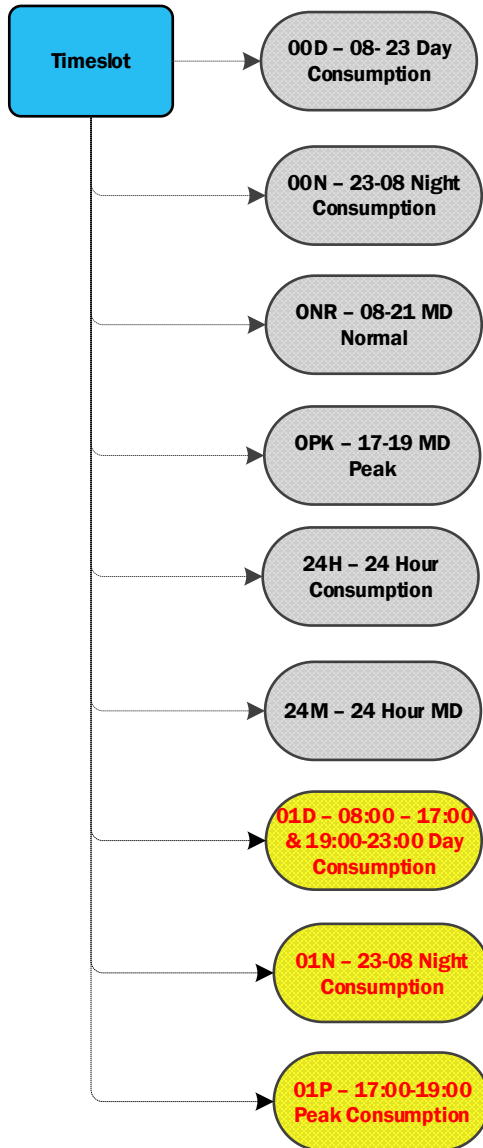

300W Withdrawn Non Interval Readings

Code

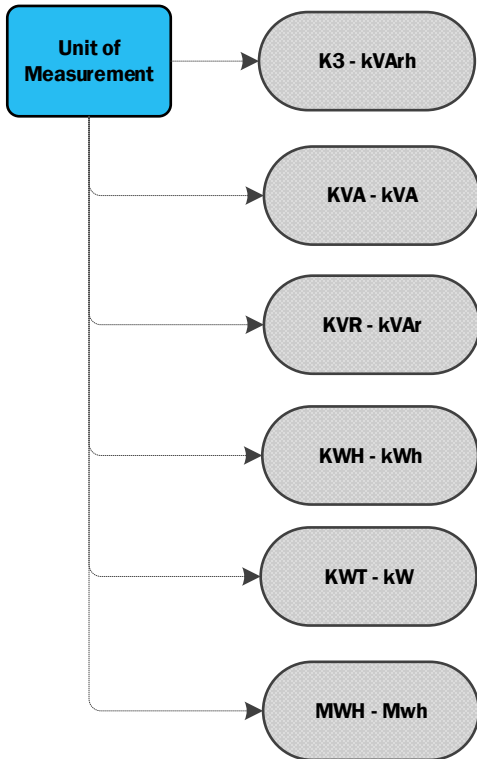

300W Withdrawn Non Interval Readings

Code

Read Reason

01 - Scheduled

17 - Change of Profile

95 - Not for CoS

02 - Special Read, Chargeable

18 - Energisation

04 - Special Read to resolve dispute

21 - Start Reading (New Register)

09 - Special Read, non chargeable

22 - Closing Reading (Register removed)

10 - Ad-hoc, no chargeable check read

23 - Meter Works Single reading

11 - Start reading after meter re-programming

26 - Change of Supplier

13 - De-Energisation

27 - Change of Legal Entity

14 - Estimate

28 - Closing read before register re-number

16 - Closing read before meter re-programming

29 - Star read after register re-number

Message

Register Level Info

RMDS

RETAIL MARKET DESIGN SERVICE

Read Reason

300W Withdrawn Non Interval Readings

Code

Read Type

A - Actual

SU - Substitute
(Interval)

CU - Customer
Reading

E - Estimate (No
Access)

ED - Estimate (DUoS
Billing has occurred)

EF - Estimate
(Implausible/ No
Read available)

EP - Estimate (Block
Planned)

EU - Estimate (Block
Unplanned)

RC - Replacement
Read

SC - Supplier
Provided Customer
Reading

Message

Register Level Info

RMDS

RETAIL MARKET DESIGN SERVICE

Read Type

300W Withdrawn Non Interval Readings

Code

Register Type

01 - 24hr

50 - IMP QH (KW)

80 - Peak

02 - Day

51 - IMP QH (kVAr)

03 - Night

52 - EXP QH(KW)

04 - NSH

53 - EXP QH (kVAr)

05 - Wattless

24M - 24 Hour MD

06 - MD Normal

70 -Import HH kW

07 - MD Peak

74 - Import 24hr kWh

08 - Cumulative MD Normal

78 - Day Off Peak

09 - Cumulative MD Peak

79 -Night Off Peak

Message

Register Level Info

RMDS

RETAIL MARKET DESIGN SERVICE

Register Type

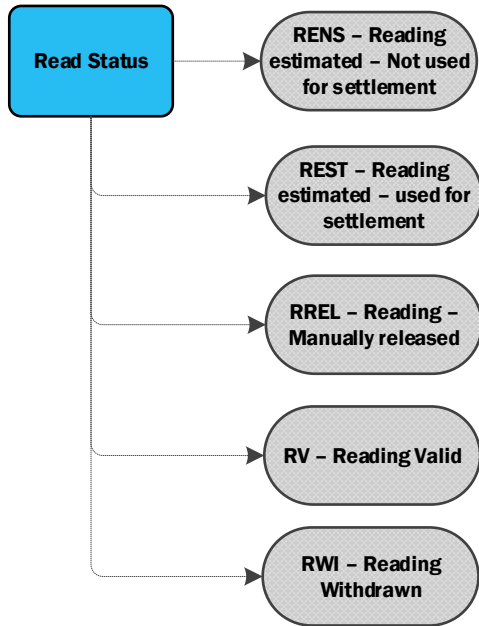

300W Withdrawn Non Interval Readings

Version Which Implemented	Source of Change	Description of Change
10.4	MCR 1155	Message format changed from ARIS to Document format.
10.6	CoBLCR 008 & CoBLCR 011	Meter Category – Removed table & replaced with link to Meter Category page on RMDS Website
13.00	V13 Smart Changes	New code added for Register Type