

# 105 Change of Supplier Confirmation

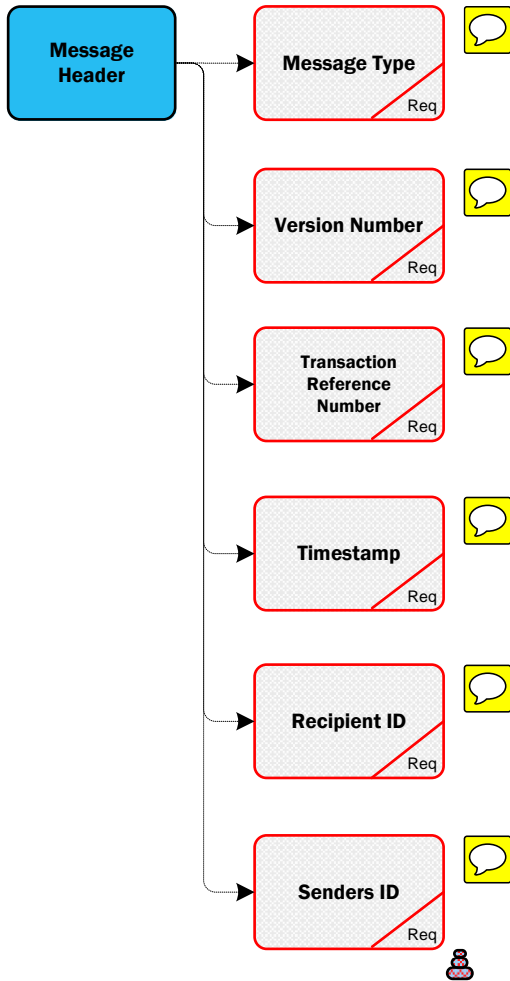

<b>105 Valid Codes</b>
<b>Meter Point Status</b>
E – Meter Point is Energised only
<b>Settlement Class</b>
N – Synthetic profile to be used in settlement P – Interval data (collected from QH Meter) to be used in settlement U – Meter point settled using unmetered profile
<b>Effective From Date</b>
<b>Please Note:</b> The date from which the New Supplier registration to the Meter Point is effective. The registration is effective from 00h00 at the start of this day. Where meter works are required as a result of the CoS request then the effective from date will be the date on which the meter works are completed.
<b>Optional/Mandatory;</b> Although the following Data Items are optional, note the following caveats:-
Load Factor: If non-profile metered maximum demand site
Generation Unit ID: Provided in the case of a generator site
Generation Unit Aggregation Code: Provided in the case of a generator site
Maximum Export Capacity: Provided in the case of a generator site





### 105 MPRN Level Info



**MPRN**  
Req 



**Market Participant Business Reference**  
Opt 

**Meter Point Status**  
Req   



**Supplier ID**  
Req   



**Supplier Unit ID**  
Req 



**SSAC**  
Req   



**Settlement Class**  
Req   



**Connection System**  
Req   

**DuoS Group**  
Req   

**Maximum Import Capacity**  
Opt 

**Meter Configuration Code**  
Opt   

**Load Factor**  
Opt   



**DLR(Distribution Loss Factor Code)**  
Req   



**Transformer Loss Factor**  
Opt 

**Medical Equipment Special Needs Details**  
Opt   



**Maximum Export Capacity**  
Opt 

**Effective From Date**  
Req 

**Read Frequency**  
Opt   

**Read Cycle Day**  
Opt 

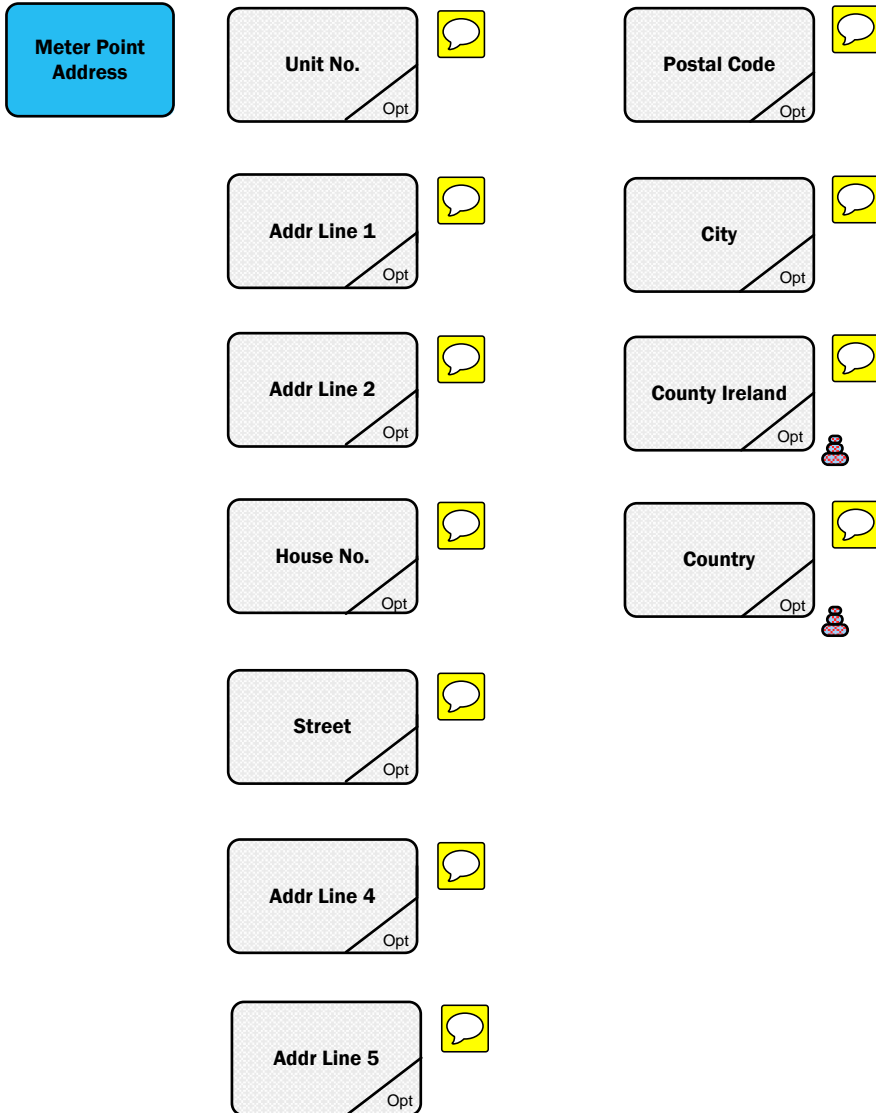
**Essential Plant Flag**  
Opt 



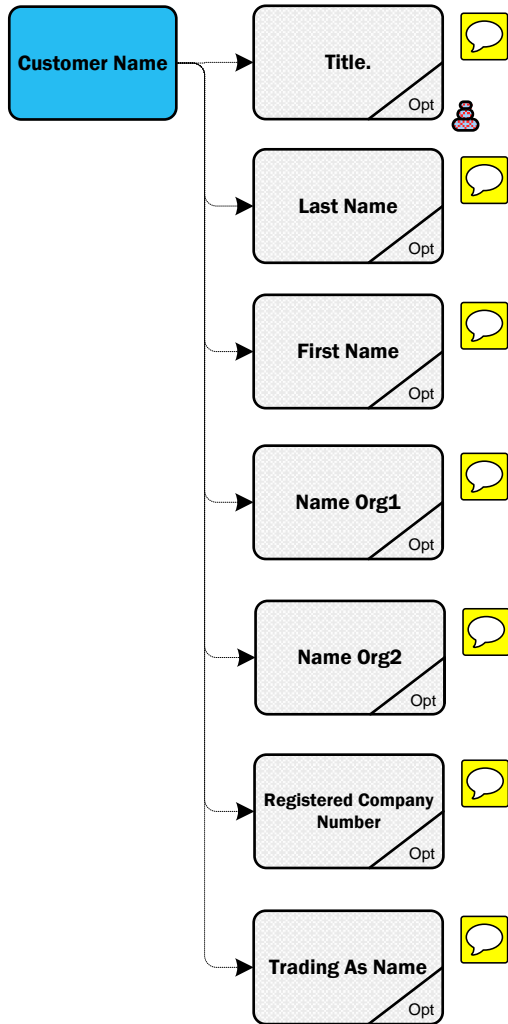

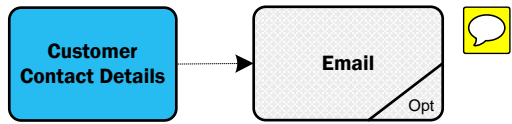



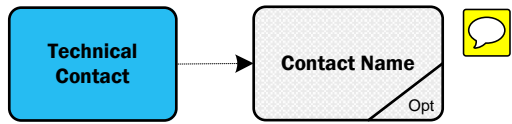



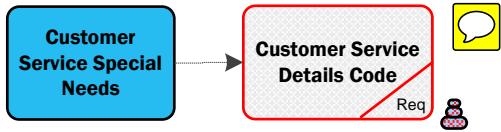

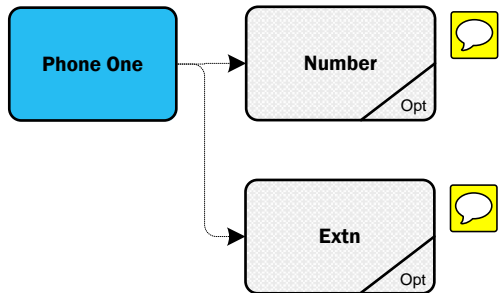

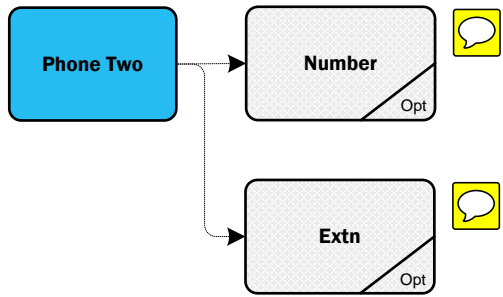

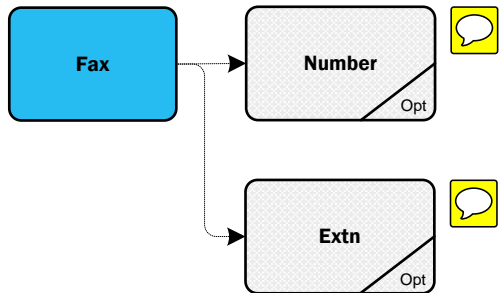

















<b>Address</b>	<b>C/O Name</b> Opt 	<b>Addr Line 5</b> Opt 
	<b>Unit No.</b> Opt 	<b>Postal Code</b> Opt 
	<b>Addr Line 1</b> Opt 	<b>City</b> Opt 
	<b>Addr Line 2</b> Opt 	<b>County Ireland</b> Opt  
	<b>House No.</b> Opt 	<b>County/State</b> Opt 
	<b>Street</b> Req 	<b>Country</b> Opt  
	<b>Addr Line 4</b> Opt 	

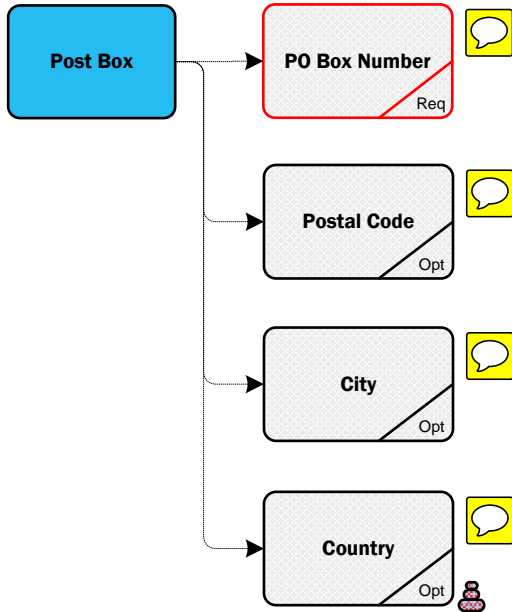

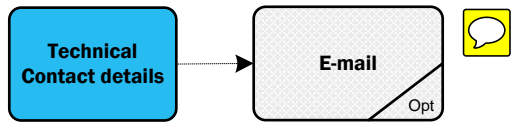



**Senders  
ID**

**Click Here for Latest  
Senders ID  
List**

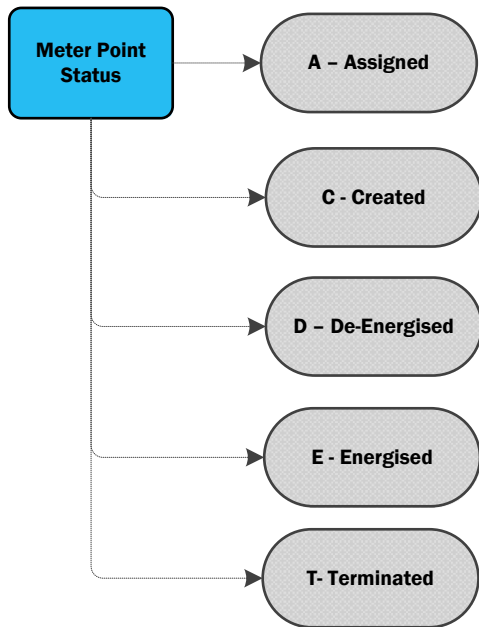

**Supplier  
ID**

**Click Here for Latest  
Supplier ID  
List**

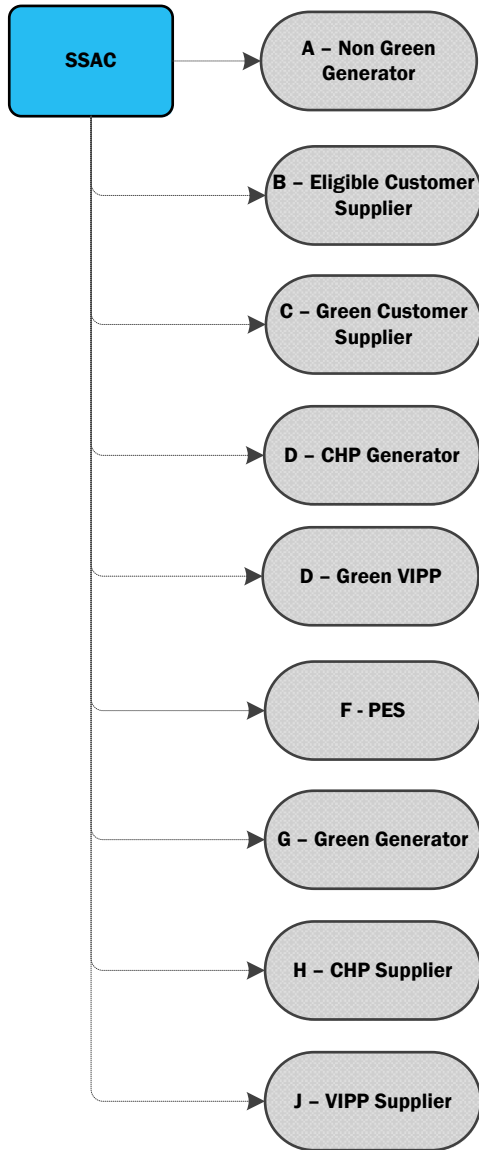

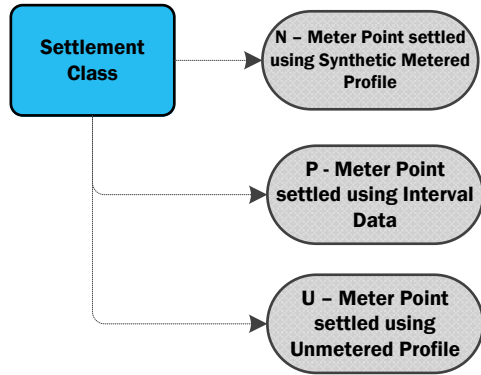

# 105 Change of Supplier Confirmation

Code

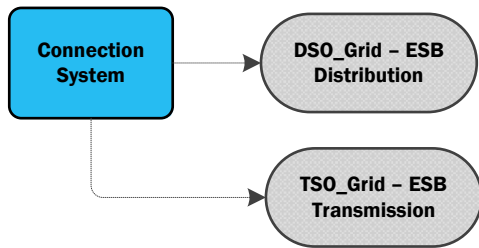

# 105 Change of Supplier Confirmation

Code

DUoS Group

AGU	DG1	Urban Domestic	DG7	MV MD
AMM	DG10	Yes	DG7A	MV MD Autoproducer
CAN	DG2	Rural Domestic	DG7B	MV MD Importing Autoproducer or CHP Producer
CIP	DG3	Public Lighting	DG8	38 kV Looped MD
COL	DG4	Unmetered Supplies	DG8A	38 kV Looped MD Autoproducer
COS	DG5	LV Non-Domestic Non-MD	DG8B	38 kV Looped MD Importing Autoproducer or CHP Producer
CUG	DG5A	LV Non-Domestic Non-MD Autoproducer	DG9	38 kV Tailed MD
DIJ	DG5B	LV Non-Domestic Non-MD Importing Autoproducer or CHP Producer	DG9A	38 kV Tailed MD Autoproducer
DSO	DG6	LV MD	DG9B	38 kV Tailed MD Importing Autoproducer or CHP Producer
IA	DG6A	LV MD Autoproducer	DG10	110kV Distribution
ICD	DG6B	LV MD Importing Autoproducer or CHP Producer	TCON	Transmission Connected

Message

MPRN Level Information

**RMDS** RETAIL MARKET DESIGN SERVICE

DUoS Group



# 105 Change of Supplier Confirmation

Code

Meter Configuration Code

MCC01 - 24 Hour	MCC10 - QH2CH_IP	MCC61 - 2x24h	MCC73 - 4x24H+NSH
MCC02 - P/N	MCC11 - QH4CH_IPXP	MCC62 - 2x24h+NSH	MCC74 - 5x24H
MCC03 - 24h+NSH	MCC50 - NONSTN	MCC63 - 2x24h+D	MCC75 - 24H+2xNSH
MCC04 - D/N+W	MCC51 - D/N+NSH	MCC64 - 2x24h+W	MCC76 - 4x24H+W
MCC05 - MDNm/PK	MCC53 - 2 X D/N	MCC65 - 3x24hr	MCC77 - 2x24H+W+NSH
MCC06 - MDNm+Pk	MCC57 - 24h+D	MCC67 - 3x24h+Day	MCC78 - 3x24H+W+NSH
MCC07 - 24H+NSH+W	MCC58 - 24h+D/N	MCC70 - 3x24H+NSH	MCC79 - 5x24H+NSH
MCC08 - 24h+W	MCC59 - 24h+D/N+W	MCC71 - 4x24H	
MCC09 - Unmetered	MCC60 - 24h+D/N+NS	MCC72 - 3x24H+W	

Message

MPRN Level Information

**RMDS** RETAIL MARKET DESIGN SERVICE

Meter Configuration Code

# 105 Change of Supplier Confirmation

Code

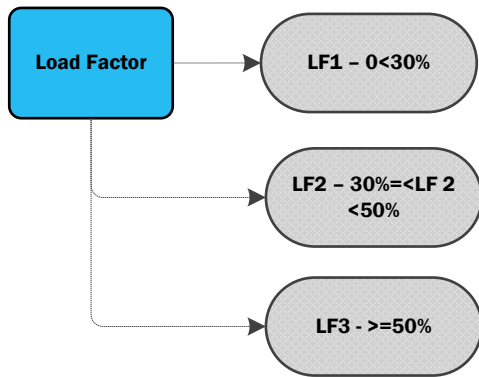

Message

MPRN Level Information

Load Factor

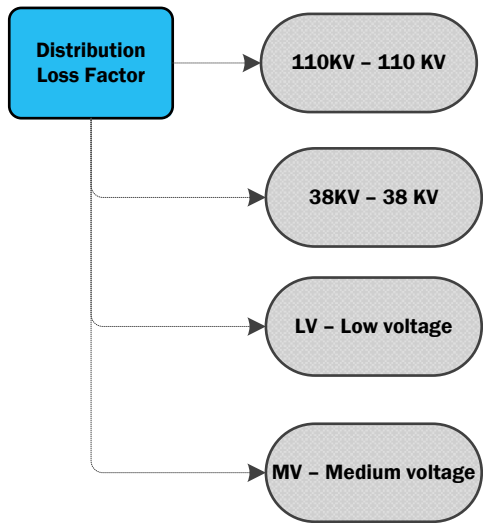

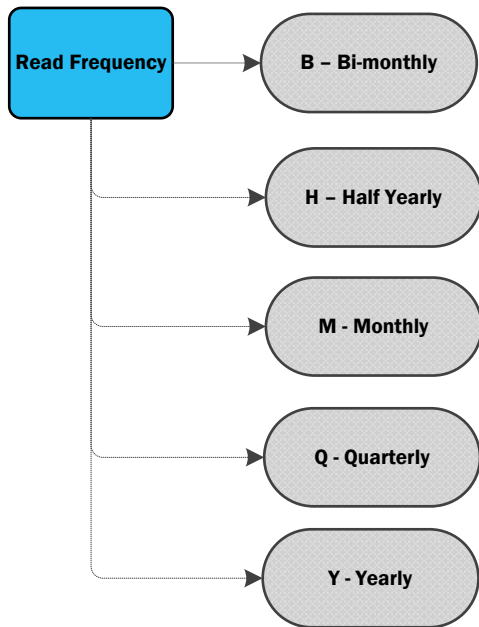

# 105 Change of Supplier Confirmation

Code

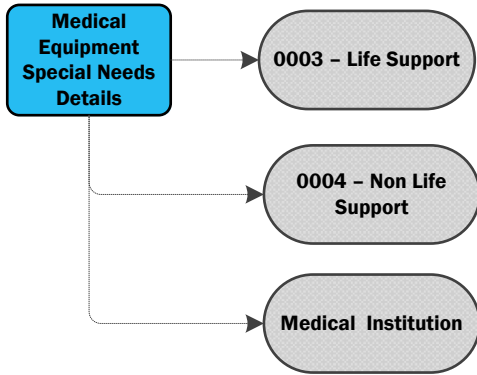

# 105 Change of Supplier Confirmation

Code

County  
Ireland

<b>AM</b>	Armagh	<b>LK</b>	Limerick	<b>ZA</b>	BHAILE ATHA CLIATHA	<b>ZN</b>	LIATROMA
<b>AT</b>	Antrim	<b>LM</b>	Leitrim	<b>ZB</b>	AN CHABHAIN	<b>ZO</b>	LOCH GARMAN
<b>CE</b>	Clare	<b>LS</b>	Laois	<b>ZC</b>	CHEATHARLACH	<b>ZP</b>	AN LONGFOIRT
<b>CK</b>	Cork	<b>LY</b>	Londonderry	<b>ZD</b>	CHIARRAI	<b>ZQ</b>	LU
<b>CN</b>	Cavan	<b>MH</b>	Meath	<b>ZE</b>	CHILL CHAINNIGH	<b>ZR</b>	LUIMNIGH
<b>CW</b>	Carlow	<b>MN</b>	Monaghan	<b>ZF</b>	CHILL DARA	<b>ZS</b>	MHAIGH EO
<b>DB</b>	Dublin	<b>MO</b>	Mayo	<b>ZG</b>	CHILL MHANTAIN	<b>ZT</b>	NA MI
<b>DE</b>	Derry	<b>OY</b>	Offaly	<b>ZH</b>	AN CHLAIR	<b>ZU</b>	MHUINEACHAIN
<b>DL</b>	Donegal	<b>RN</b>	Roscommon	<b>ZI</b>	CHORCAI	<b>ZV</b>	PHORT LAIRGE
<b>DN</b>	Dow n	<b>SO</b>	Sligo	<b>ZJ</b>	DHUN NA NGALL	<b>ZW</b>	ROS COMAIN
<b>FM</b>	Fermanagh	<b>TP</b>	Tipperary	<b>ZK</b>	NA GAILLIMHE	<b>ZX</b>	SHLIGIGH
<b>GW</b>	Galw ay	<b>TY</b>	Tyrone	<b>ZL</b>	NA HIARMHI	<b>ZY</b>	THIOBRAID ARANN
<b>KE</b>	Kildare	<b>WD</b>	Waterford	<b>ZM</b>	LAOISE	<b>ZZ</b>	UIBH FHAILI
<b>KK</b>	Kilkenny	<b>WH</b>	Westmeath				
<b>KY</b>	Kerry	<b>WW</b>	Wicklow				
<b>LD</b>	Longford	<b>WX</b>	Wexford				
<b>LH</b>	Louth						

Message

Address

Meter Point  
Address

**RMDS**

RETAIL MARKET DESIGN SERVICE

County Ireland

# 105 Change of Supplier Confirmation

Code

Country

AD	Andorra	CA	Canada	FO	Faroe Islands	JM	Jamaica	MP	N.Mariana Islnd	PW	Palau	TO	Tonga
AE	UAE	CC	Coconut Islands	FR	France	JO	Jordan	MQ	Martinique	PY	Paraguay	TP	East Timor
AF	Afghanistan	CD	Congo	GA	Gabon	JP	Japan	MR	Mauretania	QA	Qatar	TR	Turkey
AG	Antigua/Barbuda	CF	Central Afr.Rep	GB	United Kingdom	KE	Kenya	MS	Montserrat	RE	Reunion	TT	Trinidad,Tobago
AI	Anguilla	CG	Congo	GD	Grenada	KG	Kyrgyzstan	MT	Malta	RO	Romania	TV	Tuvalu
AL	Albania	CH	Sw itzerland	GE	Georgia	KH	Cambodia	MU	Mauritius	RU	Russian Fed.	TW	Taiw an
AM	Armenia	CI	Ivory Coast	GF	French Guayana	KI	Kiribati	MV	Maldives	RW	Rw anda	TZ	Tanzania
AN	Dutch Antilles	CK	Cook Islands	GH	Ghana	KM	Comoros	MW	Malaw i	SA	Saudi Arabia	UA	Ukraine
AO	Angola	CL	Chile	GI	Gibraltar	KN	St Kitts&Nevis	MX	Mexico	SB	Solomon Islands	UG	Uganda
AQ	Antarctica	CM	Cameroon	GL	Greenland	KP	North Korea	MY	Malaysia	SC	Seychelles	UM	Minor Outl.Isl.
AR	Argentina	CN	China	GM	Gambia	KR	South Korea	MZ	Mozambique	SD	Sudan	US	USA
AS	Samoa, American	CO	Colombia	GN	Guinea	KW	Kuwait	NA	Namibia	SE	Sweden	UY	Uruguay
AT	Austria	CR	Costa Rica	GP	Guadeloupe	KY	Cayman Islands	NC	New Caledonia	SG	Singapore	UZ	Uzbekistan
AU	Australia	CU	Cuba	GQ	Equatorial Gui.	KZ	Kazakhstan	NE	Niger	SH	St. Helena	VA	Vatican City
AW	Aruba	CV	Cape Verde	GR	Greece	LA	Laos	NF	Norfolk Island	SI	Slovenia	VC	St. Vincent
AZ	Azerbaijan	CX	Christmas Islnd	GS	Sth Sandw ich Is	LB	Lebanon	NG	Nigeria	SJ	Svalbard	VE	Venezuela
BA	Bosnia-Herz.	CY	Cyprus	GT	Guatemala	LC	St. Lucia	NI	Nicaragua	SK	Slovakia	VG	Brit.Virgin Is.
BB	Barbados	CZ	Czech Republic	GU	Guam	LI	Liechtenstein	NL	Netherlands	SL	Sierra Leone	VI	Amer.Virgin Is.
BD	Bangladesh	DE	Germany	GW	Guinea-Bissau	LK	Sri Lanka	NO	Norway	SM	San Marino	VN	Vietnam
BE	Belgium	DJ	Djibouti	GY	Guyana	LR	Liberia	NP	Nepal	SN	Senegal	VU	Vanuatu
BF	Burkina-Faso	DK	Denmark	HK	Hong Kong	LS	Lesotho	NR	Nauru	SO	Somalia	WF	Wallis, Futuna
BG	Bulgaria	DM	Dominica	HM	Heard/McDon.Isl	LT	Lithuania	NU	Niue Islands	SR	Suriname	WS	Western Samoa
BH	Bahrain	DO	Dominican Rep.	HN	Honduras	LU	Luxembourg	NZ	New Zealand	ST	S.Tome,Principe	YE	Yemen
BI	Burundi	DZ	Algeria	HR	Croatia	LV	Latvia	OM	Oman	SV	El Salvador	YT	Mayotte
BJ	Benin	EC	Ecuador	HT	Haiti	LY	Libya	PA	Panama	SY	Syria	YU	Yugoslavia
BM	Bermuda	EE	Estonia	HU	Hungary	MA	Morocco	PE	Peru	SZ	Swaziland	ZA	South Africa
BN	Brunei	EG	Egypt	ID	Indonesia	MC	Monaco	PF	Frenc.Polynesia	TC	Turksh Caicosin	ZM	Zambia
BO	Bolivia	EH	West Sahara	IE	Ireland	MD	Moldavia	PG	Pap. New Guinea	TD	Chad	ZW	Zimbabw e
BR	Brazil	ER	Eritrea	IL	Israel	MG	Madagascar	PH	Philippines	TF	French S.Territ		
BS	Bahamas	ES	Spain	IN	India	MH	Marshall Islnds	PK	Pakistan	TG	Togo		
BT	Bhutan	ET	Ethiopia	IO	Brit.Ind.Oc.Ter	MK	Macedonia	PL	Poland	TH	Thailand		
BV	Bouvet Island	FI	Finland	IQ	Iraq	ML	Mali	PM	St.Pier,Miquel.	TJ	Tajikstan		
BW	Botswana	FJ	Fiji	IR	Iran	MM	Myanmar	PN	Pitcairn Islnds	TK	Tokelau Islands		
BY	Belarus	FK	Falkland Islnds	IS	Iceland	MN	Mongolia	PR	Puerto Rico	TM	Turkmenistan		
BZ	Belize	FM	Micronesia	IT	Italy	MO	Macau	PT	Portugal	TN	Tunisia		

Message

Address

Meter Point  
Address

Post Box

**RMDS**

RETAIL MARKET DESIGN SERVICE

Country



# 105 Change of Supplier Confirmation

Code

Title

Br - Brother

Msgr - Monsignor

Cllr - Councillor

Ms - Ms

Dr - Doctor

Prof - Professor

Fr - Father

Rec - Reverend

Lady - Lady

Sir - Sir

Lord - Lord

Sr - Sister

Miss - Miss

Mr - Mr

Mrs - Mrs

Message

Customer Name

**RMDS** RETAIL MARKET DESIGN SERVICE

Title

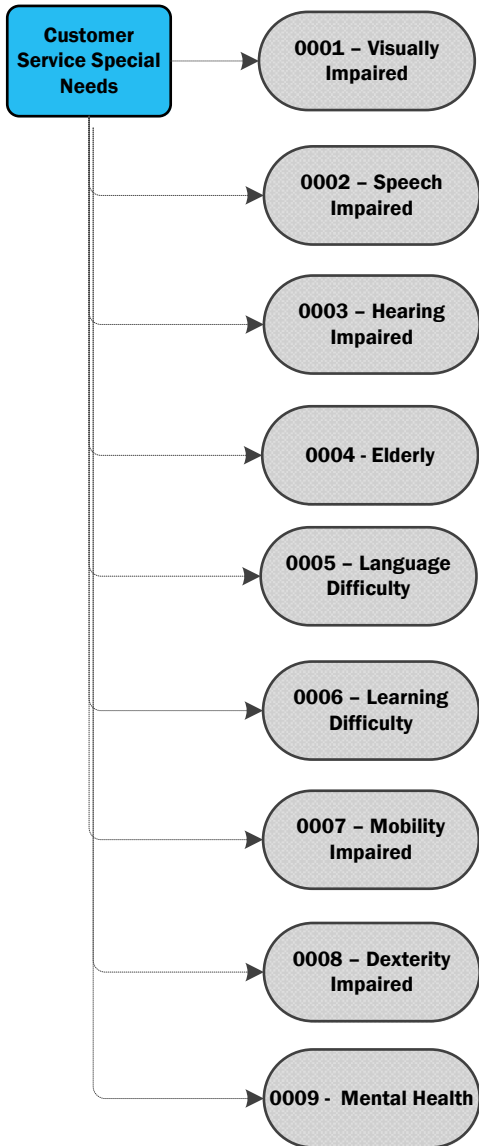

# 105 Change of Supplier Confirmation

Version Which Implemented	Source of Change	Description of Change
10.4	MCR 1155	Message format changed from ARIS to Document format.
11.0	MCR 1122	New Data Item Essential Plant Flag added
12.0	MCR 1173	Added Customer Services Special Needs codes 0008,0009