Co-Ordinated Retail Market Message Guide

ROI Implementation – Data Aggregation

<i>Document Information</i>	
Business Area:	ESB Networks
Status:	Final
Author/s:	ESBN
Version Number:	3.1
Reason for Change	Co-Ordinated Baseline V3.1

Co-Ordinated Retail Market Message Guide – Data Aggregation

Document Updates			
Name	Date	Reason	Version
H&SP Project	22/02/2012	Initial Draft	2.3
MMR 10.2	21/11/2013	Updated following approval at IGG of MCR 1134	2.4
Co-MMR 10.4	11/02/2015	Section 2.5.9 & 2.5.8 Set to Nil lines removed and information on NIEP added. SMO changed to SEMO MM 595 – The following text moved from section after Settlement Run Indicator into Aggregation period: Only one Supplier /Supplier Unit/ SSAC combination is present in the message	2.5
Co-MMR 10.6	04/11/2015	Non-Conformance AIQ 2828 – Aggregation Period description removed from table of MPD 591, 594, 598 & 595.	2.6

Co-Ordinated Retail Market Message Guide – Data Aggregation

Co-MMR 10.7	02/06/2016	AIQ 2971 - SEMO was incorrectly spelt as SMO on the Table of Contents with reference to MM 590, MM596 & MM 597 which starts on page 4. Spelling corrected. AIQ 5842 "Generation Unit ID" removed from the MPRN Level Information on the following MM: MM 595 on page 50 MM 598 on page 54 MM 597 on page 86	2.7
Schema Release V11.0	05/08/2016	Re-versioned as part of Schema Release V11.0	3.0
Co-MMR 11.1	02/10/2017	AIQ 6034 "Generation Unit ID" added to the MPRN Level Information on the following MM: MM 595 on page 50 MM 598 on page 54 MM 597 on page 86	3.1

Table of Contents

1	INTRODUCTION.....	5
1.1	PURPOSE OF THE MESSAGE IMPLEMENTATION GUIDE	5
1.2	VALIDATION	8
1.3	MESSAGE VERSION	9
1.4	NOTES.....	9
2	DATA AGGREGATION MESSAGE GROUP	11
2.1	SCOPE AND BUSINESS CONTEXT.....	11
2.2	MESSAGE USAGE SUMMARY.....	13
2.3	RELATED BUSINESS DOCUMENTS	16
2.4	MESSAGE DIRECTORY – SUPPLIER TO ESB NETWORKS.....	17
2.4.1	<i>Message 015: Change of Supplier Unit and/or SSAC Request.....</i>	<i>17</i>
2.5	MESSAGE DIRECTORY – METER DATA PROVIDER TO SUPPLIER, TSO, PARTICIPANT GENERATOR	27
2.5.1	<i>Message 115: Change of SSAC and/or Supplier Unit Confirmation</i>	<i>27</i>
2.5.2	<i>Message 115R: Change of SSAC and/or Supplier Unit Rejection.....</i>	<i>30</i>
2.5.3	<i>Message 591: Aggregated Non Interval Import DATA (SUP UNIT/SSAC, 15-min, kWh).....</i>	<i>34</i>
2.5.4	<i>Message 594: Aggregated Participant Interval Export Data(GEN UNIT, 15-min, kWh)</i>	<i>46</i>
2.5.5	<i>Message 598: Supplier NON-PARTICIPATING GEN. UNIT AGG. DATA (GEN UNIT, 15-min, kWh).....</i>	<i>51</i>
2.5.6	<i>Message 595: Aggregated Interval Import Data (Sup Unit/SSAC, 15-min,kWh).....</i>	<i>56</i>
2.5.7	<i>Message 590: SEMO Aggregated DATA (SUP UNIT, 30-min, MWh) or (Gen UNIT, 30-min, MWh).....</i>	<i>65</i>
2.5.8	<i>Message 596: SEMO Aggregated DATA (SUP UNIT, 30-min, MWh).....</i>	<i>73</i>
2.5.9	<i>Message 597: SEMO Aggregated DATA (Gen UNIT, 30-min, MWh)</i>	<i>81</i>

1 INTRODUCTION

50.5 Purpose of the Message Implementation Guide

This document is a Message Implementation Guide to assist Suppliers in:

- The construction of market messages to be sent to DSO and MRSO; and
- The interpretation of messages received from DSO and MRSO.

The Message Implementation Guides are organized into separate **Message Groups** documents based around key business processes. These are:

- Registration, including Change of Supplier
- Customer Data and Agreements
- Data Processing
- Data Aggregation
- DUoS and Transaction Payments
- Meter Works

Co-Ordinated Retail Market Message Guide – Data Aggregation

- SSA
- Unmetered
- Market Gateway Activity

This document is the **Data Aggregation** Implementation Guide.

The document contains:

- An introduction outlining the scope and business context for the message group
- A Message Usage Summary with a description of when each message is used
- A list of Related Business Documents that govern the process
- A message directory with a section for each separate message which includes:
 - A description of each message and when it should be used
 - An overview diagram of the structure of the message.
 - For messages sent by Suppliers:

Co-Ordinated Retail Market Message Guide – Data Aggregation

- A table containing composition instructions on how to populate each segment and field
- A table describing how the message will be validated
- A description of the responses that can be expected
- For messages sent by ESB Networks:
 - A table containing a description of how each segment and field will be populated.

The same type of data is often provided in several messages and, irrespective of the message type, this data is subject to common rules for population. An example is Party Contact Details.

A separate document exists to describe the population rules for these types of data, providing:

- An overview of the structure of the segment
- Instructions relating to how to populate each segment and field

This is the Common Data Segments Implementation Guide.

1.2 Validation

The document provides notes on how ESB Networks will validate the messages received. The purpose of these notes is to aid the Supplier in the population of each message and is intended to avoid instances where messages are rejected due to the incorrect population of a message field. The validation described is therefore limited to field specific validations.

Syntax validation is excluded from the validation notes. This is performed by using standard XML Schema validation against the ieXML schema provided that defines the data structures of all market messages in scope. Syntax validation includes:

- Checks that the structure of the message is correct
- Checks that all mandatory fields are provided. Mandatory fields are, however, indicated in the instructions for populations.
- Checks that any data code is selected from the list of data codes issued in the ROI Market Design.

In cases where the segment on a message fails on any of these reasons, a negative acknowledgement is sent back as a market message to the message sender containing the following information:

- The Transaction Reference Number supplied on the inbound message
- A copy of the message contents as received by ESB Networks
- A description of the error.

General market process validations that are not specific to individual market message fields are excluded. These are described in the appropriate Market Procedure Documents (MPD) referenced in each section.

If there is any inconsistency between an MPD and the Message Implementation Guide then the MPD will take precedence.

1.3 Message Version

This Message Guide refers to and is consistent with the Discussion Request (DR 176) which is based on Market Design version 8 and the 131 market message from MCR0171. NI specific validations are not included in this.

1.4 Notes

In this document the references to segment and field levels should be interpreted as follows:

- The level number indicated against the segment refers to the level of the data items and segments within that segment. Therefore, for example, in message 115R where 'MPRN Level Information –Level 2' is stated it is the data items and segments that comprise 'MPRN Level Information' that are level two items (e.g. MPRN field, Market Participant Business Reference field, Rejection Details segment). Accordingly, within this document, MPRN Level Information segment is shown as a Level 1 segment.

- Message Header is a Level 1 segment and is a child of Header Level Information.

DATA AGGREGATION MESSAGE GROUP

2.1 Scope and Business Context

The purpose of the Data Aggregation messages is to enable a Supplier to request a change of SSAC and/or Supplier Unit and to enable the Meter Data Provider to provide aggregated consumption data to the Supplier and other parties.

Data Aggregation messages are used in the following business contexts:

- The change of Supplier Unit and/or SSAC where message 015 is sent to MRSO and messages 115 or 115R may be received.
- The processing of aggregated data where messages 591, 595, 596 and 598 are received by Suppliers and messages 594 and 597 are received by Participant Generators. The 591 and 595 messages are also received by the TSO¹.
- The 590 messages are received by the SEMO. Note that the 590 message is included in this document for information only and does not form part of the Retail Market Message Catalogue nor XML schema, rather it is a Wholesale Market Message under governance of the SEMO.

¹ TSO do not receive Data Aggregation messages 591,595 from Indicative Aggregation

The following table lists the Market Process Diagrams (MPD) where the messages are used:

MPD 16 2.1	Data Aggregation
------------	------------------

Co-Ordinated Retail Market Message Guide – Data Aggregation

MPD 20	Change of SSAC and/or Supplier Unit
--------	-------------------------------------

Co-Ordinated Retail Market Message Guide – Data Aggregation

2.2 Message Usage Summary

The following table provides a trigger list for each message detailing when it is used.

Message	Title	Sender	Recipient	Trigger	Predecessor	MPD Ref.
015	Change of Supplier Unit and/or SSAC Request	Supplier	Meter Data Provider	Supplier decides to change the Supplier Unit and/or SSAC for a Meter Point	None	MPD 20
115	Change of Supplier Unit and/or SSAC Confirmation	Meter Data Provider	Supplier / TSO	Meter Data Provider accepts the Supplier request for a change of Supplier Unit and/or SSAC	015	MPD 20
115R	Change of Supplier Unit and/or SSAC Rejection	Meter Data Provider	Supplier	Meter Data Provider rejects the Supplier request for a change of Supplier Unit and/or SSAC	015	MPD 20
591	Aggregated Non Interval Import DATA (SUP UNIT/SSAC, 15-min, kWh)	Meter Data Provider	Supplier/ TSO ¹	Meter Data Provider performs Data Aggregation for Non Interval Import Meter Points, for Indicative D+1, Initial D+4, Reaggregation M+4, Reaggregation M+13 , Ad-Hoc	None	MPD 16 2.1
595	AGG. Interval Import DATA	Meter Data	Supplier/ TSO ¹	Meter Data Provider performs Data Aggregation for Interval Import Meter Points, for Indicative D+1, Initial D+4, Reaggregation M+4,	None	MPD 16 2.1

Co-Ordinated Retail Market Message Guide – Data Aggregation

Message	Title	Sender	Recipient	Trigger	Predecessor	MPD Ref.
	(SUP UNIT/SSAC, 15-min, kWh)	Provider		Reaggregation M+13 , Ad-Hoc		
596	SUPPLIER COPY of data sent to SEMO in 590 , per Supplier Unit (SUP UNIT, 30-min, MWh)	Meter Data Provider	Supplier	Meter Data Provider performs Data Aggregation for Non Interval Import and Interval Meter Points including Import and the netting of Non Participant Generator Export Data registered to the Supplier Unit , for Indicative D+1, Initial D+4, Reaggregation M+4, Reaggregation M+13 , Ad-Hoc	None	MPD 16 2.1
594	Aggregated Interval Participant Exp. DATA (GEN UNIT, 15-min, kWh)	Meter Data Provider	Participant Generator	Meter Data Provider performs Data Aggregation for Participant Generator Interval Meter Points, for Indicative D+1, Initial D+4, Reaggregation M+4, Reaggregation M+13 , Ad-Hoc	None	MPD 16 2.1
597	Participant GENERATOR COPY of data sent to SEMO in 590, per Generator Unit (GEN UNIT, 30-min, MWh)	Meter Data Provider	Participant Generator	Meter Data Provider performs Data Aggregation for Participant Generator Export Data for Indicative D+1, Initial D+4, Reaggregation M+4, Reaggregation M+13 , Ad-Hoc	None	MPD 16 2.1
598	Supplier NON-PARTICIPATING GEN. UNIT AGG. DATA	Meter Data Provider	Supplier	Meter Data Provider performs Data Aggregation for Non Participant Generator Export Data that is registered to a Supplier Unit for Indicative	None	MPD 16 2.1

Co-Ordinated Retail Market Message Guide – Data Aggregation

Message	Title	Sender	Recipient	Trigger	Predecessor	MPD Ref.
	(GEN UNIT, 15-min, kWh)			D+1, Initial D+4, Reaggregation M+4, Reaggregation M+13 , Ad-Hoc		
590 ²	590 – SEMO AGG. DATA (SUP UNIT, 30-min, MWh) (Gen UNIT, 30-min, MWh)	Meter Data Provider	SEMO	For the 590 message that contains Supplier Unit data, the Meter Data Provider performs Data Aggregation for Non Interval Import and Interval Meter Points including Import and the netting of Non Participant Generator Export Data registered to the Supplier Unit , for Indicative D+1, Initial D+4, Reaggregation M+4, Reaggregation M+13 , Ad-Hoc For the 590 message that contains Participant Generator Unit data, the Meter Data Provider performs Data Aggregation for Participant Interval Meter Points , for Indicative D+1, Initial D+4, Reaggregation M+4, Reaggregation M+13 , Ad-Hoc	None	MPD 16 2.1

¹ TSO do not receive Data Aggregation messages 591,595 from Indicative Aggregation

² As previously stated, the 590 message is included in this document for information only and does not form part of the Retail Market Message Catalogue nor XML schema, rather it is a Wholesale Market Message under governance of the SEMO.

2.3 **Related Business Documents**

Data Aggregation Briefing Paper ver. 3.4

2.4 [Message Directory – Supplier to ESB Networks](#)

2.4.1 **Message 015: Change of Supplier Unit and/or SSAC Request**

Purpose and Description of Message/Validation

Message 015 is sent by a Supplier to the Meter Data Provider in order to request a change of SSAC and/or Supplier Unit for a Meter Point to which the Supplier is already registered. This can be a change of Supplier Sub Aggregation Code (SSAC), the Supplier Unit or both. Message 015 may also be used to modify a previously requested change of SSAC and/or Supplier Unit that has not yet been implemented. The Meter Data Provider will undertake the validation

Message 015 is used in the following Market Process:

Process Number and Title		Use of Message
MPD 20	Change of SSAC and/or Supplier Unit	To request a change of SSAC and/or Supplier Unit allocated at a Meter Point.

Message 015 is not required when a Supplier is registering a Meter Point as message 010 will contain the SSAC and Supplier Unit initially required by the Supplier.

Data Hierarchy Diagram

Co-Ordinated Retail Market Message Guide – Data Aggregation

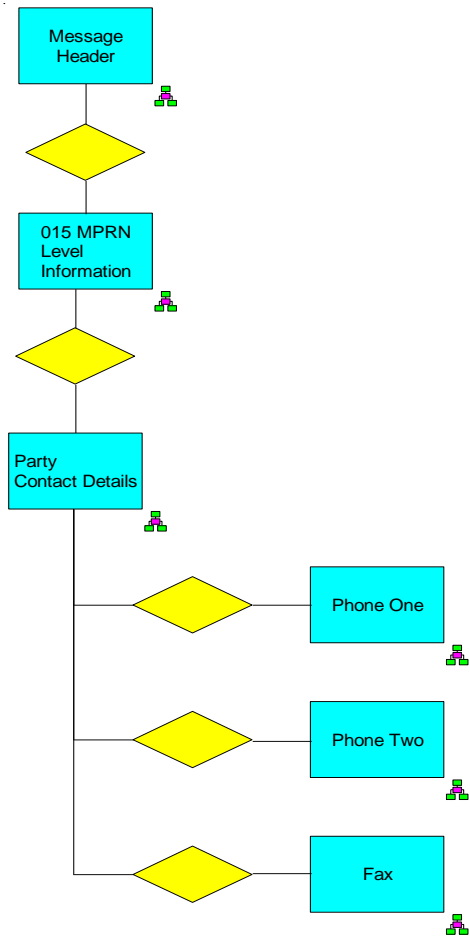

Co-Ordinated Retail Market Message Guide – Data Aggregation

Composition Instructions/Validation

Supplier should follow the instructions below in populating the Change of SSAC and/or Supplier Unit Request message. The Meter Data Provider will undertake validation of the message at segment and field level

Segment and Field Level Identifier – 015 Message			Rpt	Optionalit y	Description / Purpose and composition instructions	Validation
1 Message Header			1	Mandatory	See Common Data Segments for detailed notes on structure and population.	Not validated by MRSO
1 Meter Point Details			1	Mandatory		
2	FLD	MPRN	1	Mandatory	The unique identifying reference number for the Meter Point for which a change of SSAC is requested. All elements of the MPRN must be provided	MRSO will check that the MPRN is registered to the Supplier requesting the change of SSAC
2	FLD	Market Participant Business Reference	1	Mandatory	The Supplier must provide an internal reference number.	Not validated by Meter Data Provider
2	FLD	Supplier Unit ID	1	Mandatory	The arrangement under which consumption	MRSO will check that the Supplier Unit ID is valid

Co-Ordinated Retail Market Message Guide – Data Aggregation

Segment and Field Level Identifier – 015 Message	Rpt	Optionalit y	Description / Purpose and composition instructions	Validation
			<p>usage will be aggregated for settlement.</p> <p>This should be set to the Supplier Unit against which data is requested to be aggregated in combination with the SSAC and from the Required Date below for the Meter Point identified by the MPRN above.</p> <p>It must be selected from the list of valid Supplier Units that are registered to the Supplier in the Wholesale and Retail Markets</p> <p>If a change of Supplier Unit is requested to or from a Trading Site Supplier Unit then the details must be consistent with the Wholesale Market Registration details.</p>	<p>for use by the Supplier</p> <p>MRSO will check if a change of Supplier Unit is requested to or from a Trading Site Supplier Unit and if so then MRSO will check that the details are consistent with the Wholesale Market Registration details.</p>

Co-Ordinated Retail Market Message Guide – Data Aggregation

Segment and Field Level Identifier – 015 Message			Rpt	Optionalit y	Description / Purpose and composition instructions	Validation
2	FLD	SSAC	1	Mandatory	<p>The arrangement under which consumption usage will be aggregated for settlement.</p> <p>This should be set to the SSAC against which data is requested to be aggregated in combination with the Supplier Unit and from the Required Date below for the Meter Point identified by the MPRN above.</p> <p>It must be selected from the list of codes issued by MRSO and be an arrangement that is agreed for use by the Supplier.</p>	<p>MRSO will check that the SSAC is an arrangement that is agreed for use by the Supplier viz</p> <p>From Nov 1st , 2007 :</p> <ul style="list-style-type: none"> - A non-PES Supplier should only be using an SSAC of 'A' for registrations and 015 messages - PES should only be using an SSAC of 'F' for registrations and 015 messages
2	FLD	Supplier Id	1	Mandatory	<p>The Supplier for which the change of SSAC and/or Supplier Unit is requested.</p> <p>This must be set to the ID of the Supplier that is registered to the Meter Point.</p>	See MPRN validation above

Co-Ordinated Retail Market Message Guide – Data Aggregation

Segment and Field Level Identifier – 015 Message			Rpt	Optionalit y	Description / Purpose and composition instructions	Validation
2	SEG	Party Contact Details	1	Optional	<p>Details enabling the Supplier to be contacted in the event of a query with the request.</p> <p>See Common Data Segments for detailed notes on structure and population.</p>	Not validated by MRSO
2	FLD	Required Date	1	Mandatory	<p>. This should be set to the first settlement date from which aggregation using the requested new SSAC and/or Supplier Unit is required to take effect. It must meet the following criteria:</p> <ul style="list-style-type: none"> • The Required Date must be on or after the Required Date of any previous Change of SSAC and/or Supplier Unit request for the MPRN. • Where the Settlement Class is Interval, the Required Date must be at least one calendar month later than the effective date of any previous change of SSAC 	<p>MRSO will check the following and reject any requests that fail:</p> <ul style="list-style-type: none"> • The Required Date must be on or after the Required Date of any previous Change of SSAC and/or Supplier Unit request for the MPRN. • Where the Settlement Class is Interval, the Required Date must be at least one month later than the effective date of any previous change of SSAC and/or Supplier Unit for

Co-Ordinated Retail Market Message Guide – Data Aggregation

Segment and Field Level Identifier – 015 Message			Rpt	Optionalit y	Description / Purpose and composition instructions	Validation
					<p>and /or Supplier Unit for the MPRN.</p> <ul style="list-style-type: none"> Where the Settlement Class is Non Interval, the Required Date must be at least two calendar months later than the effective date of any previous change of SSAC and /or Supplier Unit for the MPRN. The Required Date must not be retrospective to the date of receipt by the Meter Data Provider. The Required Date must not be more than 20 days after the date of receipt by the Meter Data Provider. 	<p>the MPRN.</p> <ul style="list-style-type: none"> Where the Settlement Class is Non Interval, the Required Date must be at least two months later than the effective date of any previous change of SSAC and/or Supplier Unit for the MPRN. The Required Date must not be retrospective to the date of receipt by the Meter Data Provider. The Required Date must not be more than 20 days after the date of receipt by the Meter Data Provider.

MRSO will use the data in the message to process the Change of SSAC and/or Supplier Unit request. The validations are described above and in the relevant MPD documentation.

If the request is accepted then the following messages is generated:

ROI Market Message Guide - Data Aggregation Baseline V3.1

- Message 115 is sent to the Supplier (and TSO for Interval Meter Points) to indicate the application of the change of SSAC and/or Supplier Unit for the Meter Point.

If the request is rejected then the following message is returned to the Supplier:

- Message 115R indicates rejection of a Change of SSAC and/or Supplier Unit request.

2.5 Message Directory – Meter Data Provider to Supplier, TSO, Participant Generator

2.5.1 Message 115: Change of SSAC and/or Supplier Unit Confirmation

Purpose and Description of Message

Message 115 is sent by the Meter Data Provider to a Supplier to advise an accepted Change of SSAC and/or Supplier Unit. The 115 is also sent to the TSO for Interval Meter points.

Message 115 is used in the following Market Process:

Process Number and Title		Use of Message
MPD 20	Change of SSAC and/or Supplier Unit	To advise that a Change of SSAC and/or Supplier Unit request has been accepted for a Meter Point

Data Hierarchy Diagram

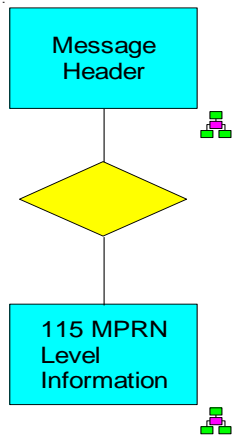

Message Structure and Interpretation

Segment and Field Level Identifier – 115 Message	Rpt	Optionality	Description and Purpose
--	-----	-------------	-------------------------

Co-Ordinated Retail Market Message Guide – Data Aggregation

Segment and Field Level Identifier – 115 Message			Rpt	Optionality	Description and Purpose
1 Message Header			1	Mandatory	See Common Data Segments for detailed notes on structure and population.
1 Meter Point Details			1	Mandatory	
2	FLD	MPRN	1	Mandatory	The unique identifying reference number for the Meter Point for which a Change of SSAC and/or Supplier Unit is accepted
2	FLD	Market Participant Reference Number	1	Mandatory	The Market Participant Reference Number provided in the 015 message sent by the Supplier. It enables the Supplier to uniquely identify the original message to which this is the response.
2	FLD	Supplier Unit ID	1	Mandatory	The Supplier Unit ID provided in the 015 message sent by the Supplier. It enables the Supplier to confirm the Supplier Unit ID that is associated with this MPRN.
2	FLD	SSAC	1	Mandatory	The SSAC which will be effective at the Meter Point from the Effective From Date below
2	FLD	Effective From Date	1	Mandatory	The date from which the SSAC and/or Supplier Unit change will be effective for the Meter Point. This is the first Settlement Date for which the new SSAC and/or Supplier Unit will be used in Data Aggregation.

2.5.2 Message 115R: Change of SSAC and/or Supplier Unit Rejection

Purpose and Description of Message

Message 115R is sent by the Meter Data Provider to a Supplier to advise a rejected Change of SSAC and/or Supplier Unit request.

Message 115R is used in the following Market Process:

Process Number and Title		Use of Message
MPD 20	Change of SSAC and/or Supplier Unit	To advise that a Change of SSAC and/or Supplier Unit request has been rejected for a Meter Point

Data Hierarchy Diagram

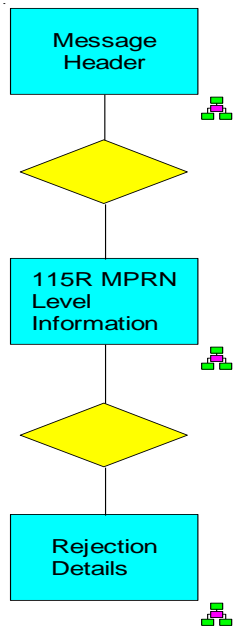

Message Structure and Interpretation

Segment and Field Level Identifier – 115R Message			Rpt	Optionality	Description and Purpose
1	Message Header		1	Mandatory	See Common Data Segments for detailed notes on structure and population.
1	Meter Point Details		1	Mandatory	
2	FLD	MPRN	1	Mandatory	The unique identifying reference number for the Meter Point for which a Change of SSAC and/or Supplier Unit is rejected
2	FLD	Market Participant Reference Number	1	Mandatory	The Market Participant Reference Number provided in the 015 message sent by the Supplier. It enables the Supplier to uniquely identify the original message to which this is the response.
2	FLD	Supplier Unit ID	1	Mandatory	The Supplier Unit ID provided in the 015 message sent by the Supplier
2	FLD	SSAC	1	Mandatory	The SSAC provided by the Supplier in the 015 message sent by the Supplier
2	FLD	Required Date	1	Mandatory	The Required Date provided by the Supplier
2	SEG	Rejection Details	1..N	Mandatory	This segment provides the details of why the 015 was rejected. One Reject Reason segment will be provided for each rejection reason

Co-Ordinated Retail Market Message Guide – Data Aggregation

Segment and Field Level Identifier – 115R Message			Rpt	Optionality	Description and Purpose
					provided.
3	FLD	Reject Reason	1	Mandatory	<p>A code to identify why data was rejected:</p> <ul style="list-style-type: none"> • IMP – MPRN is not known to MRSO or is not valid for this jurisdiction • SNR – Supplier is not registered to this Meter Point • SSS – SSAC or Supplier Unit is either not known to MRSO or is not allowed for use by the Supplier or for the Settlement Class of the Meter Point • TIM – Required date fails validation criteria (see Validation section for message 015) • TSR – a requested change which involves a Trading Site Supplier Unit is inconsistent with wholesale market registration details

2.5.3 Message 591: Aggregated Non Interval Import DATA (SUP UNIT/SSAC, 15-min, kWh)

Purpose and Description of Message

Message 591 is sent by the Meter Data Provider to the Supplier and to the TSO¹ to advise the total Non Interval import consumption (i.e. consumption for Meter Points with Non Interval metering) aggregated in Data Aggregation for a Settlement Date. A separate message is sent for each Supplier/Supplier Unit/SSAC combination.

Data is provided per 15-minute Interval for each Supplier/Supplier Unit/SSAC combination.

The Settlement Run Indicator within each message illustrates which aggregation run the message relates to, as follows

10 = Indicative

20 = Initial

30 = 1st ReAggregation at M+4

40 = 2nd ReAggregation at M+13

50 = Ad Hoc Aggregation

Co-Ordinated Retail Market Message Guide – Data Aggregation

Message 591 is used in the following Market Process:

Process Number and Title		Use of Message
MPD 16 2.1	Data Aggregation	To advise the total Non Interval consumption aggregated in Data Aggregation for a Settlement Date

¹ TSO do not receive Data Aggregation message 591 from Indicative Aggregation

Data Hierarchy Diagram

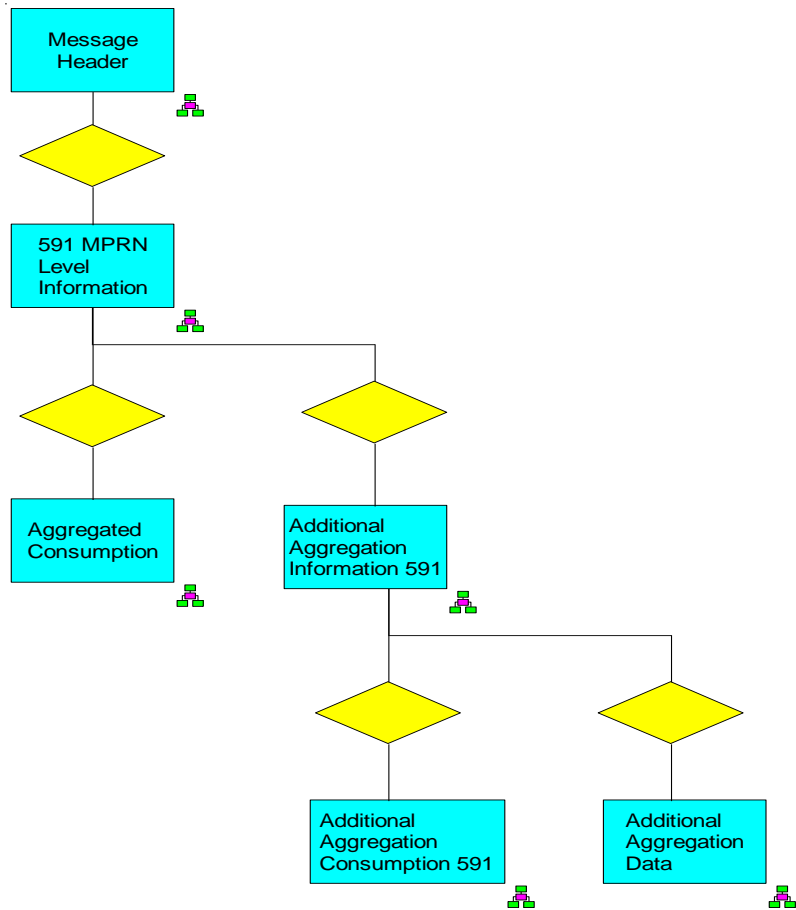

Message Structure and Interpretation

Segment and Field Level Identifier – 591 Message			Rpt	Optionality	Description and Purpose
1 Message Header			1	Mandatory	See Common Data Segments for detailed notes on structure and population.
1 Aggregation Period			1	Mandatory	
2	FLD	Settlement Date	1	Mandatory	The calendar day on which the aggregated consumption is estimated to have occurred.
2	FLD	Settlement Run Indicator	1	Mandatory	<p>The Settlement Run Indicator within each message illustrates which aggregation run the message relates to, as follows</p> <p>10 = Indicative</p> <p>20 = Initial</p> <p>30 = 1st ReAggregation at M+4</p> <p>40 = 2nd ReAggregation at M+13</p> <p>50 = Ad Hoc Aggregation</p>

Co-Ordinated Retail Market Message Guide – Data Aggregation

Segment and Field Level Identifier – 591 Message			Rpt	Optionality	Description and Purpose
2	FLD	Supplier Id	1	Mandatory	The Supplier, in combination with the Supplier Unit Id and SSAC below, for which the aggregated consumption has been estimated.
2	FLD	Supplier Unit Id	1	Mandatory	The Supplier Unit ID, in combination with the above Supplier Id and SSAC below, for which the aggregated consumption has been estimated.
2	FLD	SSAC	1	Mandatory	The SSAC, in combination with the Supplier Id and Supplier Unit Id above, for which the aggregated consumption has been estimated
2	SEG	Aggregated Consumption	0..N	Optional	<p>Data is present for each Interval Period aggregated for the Settlement Date</p> <p>The long day will contain an extra hour's data such that in 4x15-minute intervals, for 1-2 am in the morning for messages 591 there will be 100 intervals in total for the long day.</p> <p>The short day will have no data for one hour between 1-2am in the morning and for messages 591 there will be 92 intervals in total for the short day.</p>

Co-Ordinated Retail Market Message Guide – Data Aggregation

Segment and Field Level Identifier – 591 Message			Rpt	Optionality	Description and Purpose
3	FLD	Interval Period Timestamp	1	Mandatory	The start time of the interval period for which aggregated consumption has been estimated.
3	FLD	Settlement Interval	1	Mandatory	The Settlement Interval field in messages 591 contains a sequential counter value starting at 1.
3	FLD	Aggregated Consumption	1	Mandatory	The consumption estimated for Supplier/Supplier Unit/SSAC combination within the period expressed in kWh before adjustment for Distribution Losses.
3	FLD	Loss Adjusted Aggregated Consumption	1	Mandatory	The consumption estimated for Supplier/Supplier Unit/SSAC combination within the period expressed in kWh after adjustment for Distribution Losses.
2	SEG	Additional Aggregation Information	0..N	Optional –See Description	<p>Data is available to Suppliers for each Profile / DLF combination within Supplier / Supplier Unit/SSAC.</p> <p>The following statement will be true for the composition of the 591 Market Message</p> <ul style="list-style-type: none"> Invalid Combinations should not be populated in the message, however if there are no MPRNs registered for a valid combination then a count of zero should be populated in

Co-Ordinated Retail Market Message Guide – Data Aggregation

Segment and Field Level Identifier – 591 Message			Rpt	Optionality	Description and Purpose
					<p>the message</p> <p>The implication of this statement is that where the DLF is LV:</p> <ul style="list-style-type: none"> the count of MPRNs , Load profile and DLF will always be included for each of the Load Profiles 01-12 in the segment Additional Aggregation Information And where the Count of MPRNs is zero, none of the lower level segments will be populated viz no Additional Aggregated Consumption, no Additional Aggregation Data segments for that Load Profile/DLF combination <p>And where the DLF is not LV:</p> <ul style="list-style-type: none"> there should be none of the segments : Additional Aggregation Information , Additional Aggregated Consumption, Additional Aggregation Data segments
3	FLD	DLF Code	1	Mandatory	The Distribution Loss Factor Code, in combination with the Load Profile below and the Supplier/Supplier Unit/ SSAC combination above, for which the additional aggregated consumption data has

Co-Ordinated Retail Market Message Guide – Data Aggregation

Segment and Field Level Identifier – 591 Message			Rpt	Optionality	Description and Purpose
					been provided.
3	FLD	Load Profile	1	Mandatory	The Standard Load Profile, in combination with the DLF Code and the Supplier/Supplier Unit/SSAC combination above, for which the additional aggregated consumption data has been provided.
3	FLD	Count of MPRN	1	Optional	The number of MPRN processed in the aggregation run for this Profile / DLF combination within this Supplier / Supplier Unit/SSAC classification.
3	SEG	Additional Aggregation Consumption	0..N	Optional	<p>Data is present for each Interval for which the additional aggregated data is provided.</p> <p>The long day will contain an extra hour's data such that in 4x15-minute intervals, for 1-2 am in the morning for messages 591 there will be 100 intervals in total for the long day.</p> <p>The short day will have no data for one hour between 1-2am in the morning and for messages 591 there will be 92 intervals in total for the short day.</p>

Co-Ordinated Retail Market Message Guide – Data Aggregation

Segment and Field Level Identifier – 591 Message			Rpt	Optionality	Description and Purpose
					<p>The following statement will be true for the composition of the 591 Market Message</p> <ul style="list-style-type: none"> Invalid Combinations should not be populated in the message, however if there are no MPRNs registered for a valid combination then a count of zero should be populated in the message <p>The implication of this statement is that where the DLF is LV:</p> <ul style="list-style-type: none"> the count of MPRNs , Load profile and DLF will always be included for each of the Load Profiles 01-12 in the segment Additional Aggregation Information And where the Count of MPRNs is zero, none of the lower level segments will be populated viz no Additional Aggregated Consumption, no Additional Aggregation Data segments for that Load Profile/DLF combination <p>And where the DLF is not LV:</p> <ul style="list-style-type: none"> there should be none of the segments : Additional

Co-Ordinated Retail Market Message Guide – Data Aggregation

Segment and Field Level Identifier – 591 Message			Rpt	Optionality	Description and Purpose	
					Aggregation Information , Additional Aggregated Consumption, Additional Aggregation Data segments	
	4	FLD	Interval Period Timestamp	1	Mandatory	The start time of the interval period for which the additional aggregated consumption data has been provided.
	4	FLD	Settlement Interval	1	Mandatory	The Settlement Interval field in messages 591 contains a sequential counter value starting at 1.
	4	FLD	Aggregated Consumption	1	Mandatory	The consumption estimated for Supplier/Supplier Unit/SSAC/DLF Code/Load Profile combination within the period expressed in kWh before adjustment for Distribution Losses.
3	SEG	Additional Aggregation Data		0..N	Optional	<p>Summary aggregation data is available to Suppliers for each Profile / DLF combination within Supplier /Supplier Unit/ SSAC detailing the total Usage Factor and MPRN count per Time of Use (Day, Night, 24Hr).</p> <p>The following statement will be true for the composition of the 591 Market Message</p> <ul style="list-style-type: none"> Invalid Combinations should not be populated in the message, however if there are no MPRNs registered for a valid combination then a count of zero should be populated in

Co-Ordinated Retail Market Message Guide – Data Aggregation

Segment and Field Level Identifier – 591 Message				Rpt	Optionality	Description and Purpose
						<p>the message</p> <p>The implication of this statement is that where the DLF is LV:</p> <ul style="list-style-type: none"> the count of MPRNs , Load profile and DLF will always be included for each of the Load Profiles 01-12 in the segment Additional Aggregation Information And where the Count of MPRNs is zero, none of the lower level segments will be populated viz no Additional Aggregated Consumption, no Additional Aggregation Data segments for that Load Profile/DLF combination <p>And where the DLF is not LV:</p> <ul style="list-style-type: none"> there should be none of the segments : Additional Aggregation Information , Additional Aggregated Consumption, Additional Aggregation Data segments
	4	FLD	Time of Use	1	Optional	The time slot to which the additional aggregated data refers, i.e. Day, Night, 24 Hour or Unmetered Supply. Unmetered Supply occurs only where the Load Profile in the parent Additional Aggregated

Co-Ordinated Retail Market Message Guide – Data Aggregation

Segment and Field Level Identifier – 591 Message			Rpt	Optionality	Description and Purpose
					Information segment is 10, 11 or 12.
4	FLD	Total Usage Factor	1	Optional	The total sum of the usage factors processed in the aggregation run for this Profile / DLF combination within the Supplier /Supplier Unit/SSAC classification.

2.5.4 Message 594: Aggregated Participant Interval Export Data (GEN UNIT, 15-min, kWh)

Purpose and Description of Message

Message 594 is sent by the Meter Data Provider to the Participant Generator to advise the Interval export at a Participant Generation Unit included in Data Aggregation for a Settlement Date. A separate message is sent for each Participant Generator Unit and Settlement Date.

Participant Generator Messages that sent to a Supplier will carry a recipient ID of the nominated Supplier

Co-Ordinated Retail Market Message Guide – Data Aggregation

Data is provided per 15-minute Interval for each Participant Generator Unit.

The Settlement Run Indicator within each message illustrates which aggregation run the message relates to, as follows

- 10 = Indicative
- 20 = Initial
- 30 = 1st ReAggregation at M+4
- 40 = 2nd ReAggregation at M+13
- 50 = Ad Hoc Aggregation

Message 594 is used in the following Market Process:

Process Number and Title		Use of Message
MPD 16 2.1	Data Aggregation	To advise the Participant Interval export included in Data Aggregation for a Settlement Date

Data Hierarchy Diagram

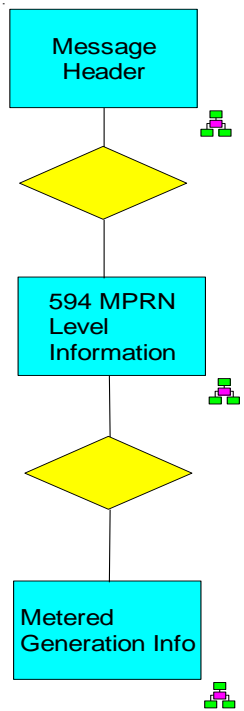

Message Structure and Interpretation

Segment and Field Level Identifier – 594 Message			Rpt	Optionality	Description and Purpose
1 Message Header			1	Mandatory	See Common Data Segments for detailed notes on structure and population.
1 Aggregation period			1	Mandatory	
2	FLD	Settlement Date	1	Mandatory	The calendar day for which the export value has been calculated.
2	FLD	Settlement Run Indicator	1	Mandatory	<p>The Settlement Run Indicator within each message illustrates which aggregation run the message relates to, as follows</p> <p>10 = Indicative</p> <p>20 = Initial</p> <p>30 = 1st ReAggregation at M+4</p> <p>40 = 2nd ReAggregation at M+13</p> <p>50 = Ad Hoc Aggregation</p>

Co-Ordinated Retail Market Message Guide – Data Aggregation

Segment and Field Level Identifier – 594 Message				Rpt	Optionality	Description and Purpose
2	FLD	Generation Unit ID		1	Mandatory	Only one Participant Generation Unit is present in the message and this will contain the Participant Generator Unit ID
2	SEG	Metered Generation		1..N	Mandatory	Data is present for each Interval Period on the Settlement Date. The long day will contain an extra hour's data such that in 4x15-minute intervals, for 1-2 am in the morning for messages 594 there will be 100 intervals in total for the long day. The short day will have no data for one hour between 1-2am in the morning and for messages 594 there will be 92 intervals in total for the short day.
3	FLD	Interval Period Timestamp		1	Mandatory	The start time of the period for which export value has been calculated.
3	FLD	Settlement Interval		1	Mandatory	The Settlement Interval field in message 594 contains a sequential counter value starting at 1.
3	FLD	Generation Unit Metered Generation		1	Mandatory	The export value calculated for the Generation Unit in the period expressed in kWh before adjustment for Distribution Losses.
3	FLD	Loss Adjusted Generation Unit Metered Generation		1	Mandatory	The export value calculated for the Generation Unit in the period expressed in kWh after adjustment for Distribution Losses.

2.5.5 Message 598: Supplier NON-PARTICIPATING GEN. UNIT AGG. DATA (GEN UNIT, 15-min, kWh)

Purpose and Description of Message

Message 598 is sent by the Meter Data Provider to the Supplier to whom the Non-Participant Generator Unit data is registered, to advise of the Interval export at a Non-Participant Generation Unit included in Aggregation for a Settlement Date. A separate message is sent for each Non Participant Generator Unit and Settlement Date.

Data is provided per 15-minute Interval for each Non-Participant Generation Unit.

The Settlement Run Indicator within each message illustrates which aggregation run the message relates to, as follows

- 10 = Indicative
- 20 = Initial
- 30 = 1st ReAggregation at M+4
- 40 = 2nd ReAggregation at M+13
- 50 = Ad Hoc Aggregation

Message 598 is used in the following Market Process:

Process Number and Title	Use of Message
--------------------------	----------------

Co-Ordinated Retail Market Message Guide – Data Aggregation

MPD 16 2.1	Data Aggregation	To advise the Supplier to whom the Non Participant Generator Unit data is registered of the Interval export included in Data Aggregation for a Settlement Date
---------------	------------------	--

Data Hierarchy Diagram

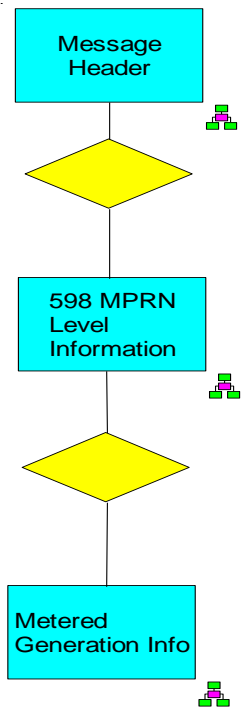

Message Structure and Interpretation

Segment and Field Level Identifier – 598 Message			Rpt	Optionality	Description and Purpose
1 Message Header			1	Mandatory	See Common Data Segments for detailed notes on structure and population.
1 Aggregation period			1	Mandatory	
2	FLD	Settlement Date	1	Mandatory	The calendar day for which the export value has been calculated.
2	FLD	Settlement Run Indicator	1	mandatory	<p>The Settlement Run Indicator within each message illustrates which aggregation run the message relates to, as follows</p> <p>10 = Indicative</p> <p>20 = Initial</p> <p>30 = 1st ReAggregation at M+4</p> <p>40 = 2nd ReAggregation at M+13</p> <p>50 = Ad Hoc Aggregation</p>
2	FLD	Generation Unit ID	1	Mandatory	Only one Non Participant Generation Unit is present in the message and this will contain the Export Arrangement Reference Number

Co-Ordinated Retail Market Message Guide – Data Aggregation

Segment and Field Level Identifier – 598 Message			Rpt	Optionality	Description and Purpose
2	SEG	Metered Generation	1..N	Mandatory	<p>Data is present for each Interval Period on the Settlement Date.</p> <p>The long day will contain an extra hour's data such that in 4x15-minute intervals, for 1-2 am in the morning for messages 594 there will be 100 intervals in total for the long day.</p> <p>The short day will have no data for one hour between 1-2am in the morning and for messages 598 there will be 92 intervals in total for the short day.</p>
3	FLD	Interval Period Timestamp	1	Mandatory	The start time of the period for which export value has been calculated.
3	FLD	Settlement Interval	1	Mandatory	The Settlement Interval field in message 598 contains a sequential counter value starting at 1.
3	FLD	Generation Unit Metered Generation	1	Mandatory	The export value calculated for the Generation Unit in the period expressed in kWh before adjustment for Distribution Losses.
3	FLD	Loss Adjusted Generation Unit Metered Generation	1	Mandatory	The export value calculated for the Generation Unit in the period expressed in kWh after adjustment for Distribution Losses.

2.5.6 Message 595: Aggregated Interval Import Data (Sup Unit/SSAC, 15-min,kWh)

Purpose and Description of Message

Message 595 is sent by the Meter Data Provider to the Supplier and to TSO¹ to advise the total Interval consumption (i.e. consumption for Meter Points with Interval metering) aggregated in Initial Aggregation for a Settlement Date. A separate message is sent for each Supplier/Supplier Unit/SSAC combination.

Data is provided per 15-minute Interval for each Supplier/Supplier Unit/SSAC combination.

The Settlement Run Indicator within each message illustrates which aggregation run the message relates to, as follows

- 10 = Indicative
- 20 = Initial
- 30 = 1st ReAggregation at M+4
- 40 = 2nd ReAggregation at M+13
- 50 = Ad Hoc Aggregation

Message 595 is used in the following Market Process:

Process Number and Title		Use of Message
MPD 16 2.1	Data Aggregation	To advise the total Interval Import consumption aggregated in Data Aggregation for a Settlement Date

¹ TSO do not receive Data Aggregation message 595 from Indicative Aggregation

Data Hierarchy Diagram

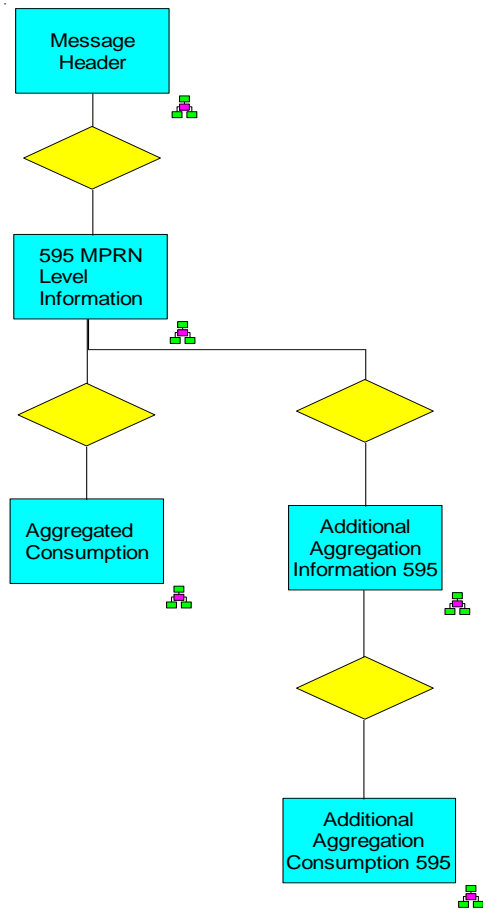

Co-Ordinated Retail Market Message Guide – Data Aggregation

Message Structure and Interpretation

Segment and Field Level Identifier – 595 Message			Rpt	Optionality	Description and Purpose
1 Message Header			1	Mandatory	See Common Data Segments for detailed notes on structure and population.
1 Aggregation Period			1	Mandatory	
2	FLD	Settlement Date	1	Mandatory	The calendar day for which the aggregated consumption has been calculated.
2	FLD	Settlement Run Indicator	1	mandatory	The Settlement Run Indicator within each message illustrates which aggregation run the message relates to, as follows 10 = Indicative 20 = Initial 30 = 1st ReAggregation at M+4 40 = 2nd ReAggregation at M+13 50 = Ad Hoc Aggregation
2	FLD	Supplier Id	1	Mandatory	The Supplier, in combination with the SSAC below, for which the aggregated consumption has been calculated. Only one Supplier /Supplier Unit/ SSAC combination is present in the message

Co-Ordinated Retail Market Message Guide – Data Aggregation

Segment and Field Level Identifier – 595 Message			Rpt	Optionality	Description and Purpose
2	FLD	Supplier Unit ID	1	Mandatory	The Supplier Unit ID, in combination with the above Supplier Id and SSAC below, for which the aggregated consumption has been calculated
2	FLD	SSAC	1	Mandatory	The SSAC, in combination with the Supplier above, for which the aggregated consumption has been calculated.
2	FLD	Percentage of MPRNs Estimated	1	Optional	The Percentage of MPRNs Estimated field will display the percentage of MPRNs, per Supplier Unit/SSAC combination, that has 50% or more intervals estimated in that day. An MPRN will said to be estimated if 50% or more of the interval values for each settlement date have a status of Estimated
2	FLD	Percentage of Consumption Actual	1	Mandatory	The Percentage of Consumption Actual field will display the percentage of consumption, per Supplier Unit/SSAC combination, that is recorded as actual interval values on that day. The total consumption across all actual intervals for that Supplier Unit / SSAC on that day will be added and compared to the total consumption across all estimated intervals to give the percentage actual.
2	SEG	Aggregated Consumption	0..N	Optional	<p>Data is present for each Interval Period aggregated for the Settlement Date</p> <p>The long day will contain an extra hour's data such that in 4x15-minute intervals, for 1-2 am in the morning for messages 595 there will be 100 intervals in total for the long day.</p> <p>The short day will have no data for one hour between 1-2am in the morning and for messages 595 there will be 92 intervals in total for</p>

Co-Ordinated Retail Market Message Guide – Data Aggregation

Segment and Field Level Identifier – 595 Message			Rpt	Optionality	Description and Purpose
					the short day
3	FLD	Interval Period Timestamp	1	Mandatory	The start time of the period for which aggregated consumption has been calculated.
3	FLD	Settlement Interval	1	Mandatory	The Settlement Interval field in message 595 contains a sequential counter value starting at 1.
3	FLD	Aggregated Consumption	1	Mandatory	The consumption calculated for Supplier/Supplier Unit/SSAC combination within the period expressed in kWh before adjustment for Distribution Losses.
3	FLD	Loss Adjusted Aggregated Consumption	1	Mandatory	The consumption calculated for Supplier/Supplier Unit/ SSAC combination within the period expressed in kWh after adjustment for Distribution Losses.
2	SEG	Additional Aggregation Information	0..N	Optional - See Description	Data is available to Suppliers for each DLF within Supplier / Supplier Unit/ SSAC.
3	FLD	DLF Code	1	Mandatory	The Distribution Loss Factor Code, in combination with the Supplier/Supplier Unit/SSAC combination above, for which the additional aggregated consumption data has been provided.
3	FLD	Count of MPRN	1	Mandatory	The number of MPRN processed in the aggregation run for this Profile / DLF combination (DLF only for the 595 MM) within this Supplier Unit / SSAC

Co-Ordinated Retail Market Message Guide – Data Aggregation

Segment and Field Level Identifier – 595 Message			Rpt	Optionality	Description and Purpose
					classification.
3	SEG	Aggregated Consumption	0..N	Optional	Data is present for each Interval aggregated for the Settlement Date. The long day will contain an extra hour's data such that in 4x15-minute intervals, for 1-2 am in the morning for messages 595 there will be 100 intervals in total for the long day. The short day will have no data for one hour between 1-2am in the morning and for messages 595 there will be 92 intervals in total for the short day.
4	FLD	Interval Period Timestamp	1	Mandatory	The start time of the period for which the additional aggregated consumption data has been provided.
4	FLD	Settlement Interval	1	Mandatory	The Settlement Interval field in message 595 contains a sequential counter value starting at 1.
4	FLD	Aggregated Consumption	1	Mandatory	The consumption calculated for Supplier/Supplier Unit/SSAC/DLF Code combination within the period expressed in kWh before adjustment for Distribution Losses.
4	FLD	Loss Adjusted Aggregated Consumption	1	Mandatory	The consumption calculated for Supplier/Supplier Unit/SSAC/DLF Code combination within the period expressed in kWh after adjustment for Distribution Losses.

2.5.7 Message 590: SEMO Aggregated DATA (SUP UNIT, 30-min, MWh) Gen UNIT, 30-min, MWh)

Details of the 590 message are included in this document for information only and do not form part of the Retail Market Message Catalogue nor XML schema, rather it is a Wholesale Market Message under governance of the SEMO.

Purpose and Description of Message

Message 590 is sent by the Meter Data Provider to the SEMO and in accordance with AP16, it is non price-affecting demand and generation data ie NPED and NPEG... There are two individual messages populated and sent to the SEMO from each aggregation, one containing Supplier Unit Data and the other containing Participant Generator Unit Data.

For the 590 message that contains Supplier Unit data, the Meter Data Provider performs Data Aggregation for Non Interval Import and Interval Meter Points including Import and the netting of Non Participant Generator Export Data registered to the Supplier Unit for the Settlement Date.

For the 590 message that contains Participant Generator Unit data, the Meter Data Provider performs Data Aggregation of Interval Export for Participant Interval Meter Points for the Settlement Date.

Data is provided per 30-minute Interval for each Supplier Unit.

Data is provided per 30-minute Interval for each Participant Generator Unit.

The Settlement Run Indicator within each message illustrates which aggregation run the message relates to, as follows

- 10 = Indicative
- 20 = Initial
- 30 = 1st ReAggregation at M+4
- 40 = 2nd ReAggregation at M+13
- 50 = Ad Hoc Aggregation

Please note the following requirements of SEMO:

- Interval period in which aggregated data is provided to SEMO is Half-hourly
- All Aggregated data for SEMO is provided in MWh and specifically not kWh
- Generator data is not signed, Import data is signed as negative

As such, these requirements result in the following further pre-processing steps for the Meter Data Provider:

A. the Supplier Unit data:

- Per 15-minute interval, adding the Loss Adjusted Non Interval Import and Interval Import Data that has been summated to Supplier Unit level
- Summate from 15-minutes to 30-minutes settlement interval
- Subtract , per 30-minute settlement interval, the non-participant generation data that has been summated per Supplier Unit from the relevant 30-minute settlement interval for the Loss Adjusted Import that has been aggregated per Supplier Unit
- Convert kWh data to MWh by division by 1000, representing MWh to three decimal places

The loss adjusted aggregated data is provided to the SEMO using message 590. A copy of aggregated data relevant to a Supplier is provided to that Supplier using message 596.

B. the Participant Generator Unit data:

- Per 15-minute interval, summate from 15-minutes to 30-minutes settlement interval the loss adjusted Export kWh generation.
- Convert kWh data to MWh by division by 1000, representing MWh to three decimal places

The loss adjusted aggregated data is provided to the SEMO using message 590. A copy of aggregated data relevant to a Participant Generator is provided to that Participant Generator using message 597.

Reading Data Status field

All SEM settlement statements are required to indicate if the settlement data is estimated or not. The Reading Data Status field in the 590 and 596 messages will either contain an estimated or an actual flag where a code of 0 denotes estimated readings while a code of 1 denotes Actual readings.

In this situation the following is the definition of 'Estimated':

- For each Supplier Unit aggregation D+1, D+4, M+4, M+13, there are service level agreements for the different percentages of estimated data. Service level targets for meter readings are to be agreed, and where met the Supplier Units aggregated data are marked with an actual flag (1), otherwise an Estimated flag (0), per half hourly interval
- Interval meter data only [ie Interval] and not Non Interval data is considered in arriving at the estimated or actual flag.

The rules for determining whether an aggregation of meter readings is estimated or actual is based on the concept that there is only one meter reading to be considered per MPRN. This may not be the case where there is Generation on the site, particularly where there is splitting of the generation between several suppliers outside of the market.

- Therefore, when calculating the value of this flag the actual/estimated value is determined only from import meters

- Also, where two 15 minute intervals are amalgamated together to a 30 minute trading period, if either or both of the 15-minute meter reading is an estimate then the 30 minute trading period metered volume is considered as an estimate.

Rounding

Rounding for 590 and also the 596 and 597 messages is carried out as follows:

- Convert kWh data to MWh by division by 1000, representing MWh to three decimal places
- If the value of the 4th decimal place after division by 1000 is 5 or greater then the 3rd decimal place is rounded up by one.

As the proportion of errors are thought to be higher for consumption that is not recorded by profile metering MRSO are obliged to communicate the Non Interval Energy Proportion (NIEP) per settlement period per supplier unit. The NIEP is calculated using the following:

- $\text{Total Non Interval Consumption with DLF applied} / \text{Total Non Interval and Interval Consumption with DLF applied}$.
- The calculation is based on values in KWH per 30 minutes. The NIEP value is rounded to 8 decimal places.

The NIEP value will be sent on every new 590 (NPED) and 596 message that is generated after the Global Aggregation go live date.

Message 590 is used in the following Market Process:

Process Number and Title		Use of Message
MPD 16 2.1	Data Aggregation	<p>For the 590 message that contains Supplier Unit data, the Meter Data Provider performs Data Aggregation for Non Interval Import and Interval Meter Points including Import and the netting of Non Participant Generator Export Data registered to the Supplier Unit , for Indicative D+1, Initial D+4, Reaggregation M+4, Reaggregation M+13 , Ad-Hoc</p> <p>For the 590 message that contains Participant Generator Unit data, the Meter Data Provider performs Data Aggregation for Participant Interval Meter Points , for Indicative D+1, Initial D+4, Reaggregation M+4, Reaggregation M+13 , Ad-Hoc</p>

Data Hierarchy Diagram

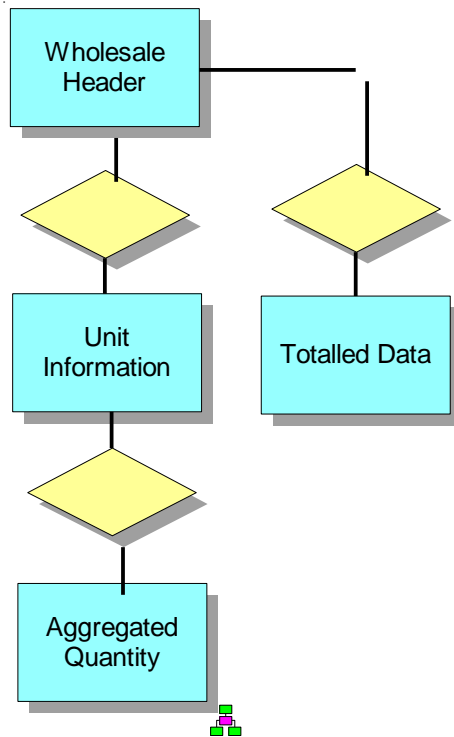

Message Structure and Interpretation

Note that the structure and interpretation of the 590 message is under the governance of the Wholesale Market and is managed by SEMO and is not considered further in this document.

2.5.8 Message 596: SEMO Aggregated DATA (SUP UNIT, 30-min, MWh)

Purpose and Description of Message

Message 596 is sent by the Meter Data Provider to the Supplier to advise what has been sent to the SEMO in a 590 message from each aggregation run. There is a separate message 596 for each **Supplier Unit** that has been included in each 590 message and which is registered to the Supplier. The 596 contains Data Aggregation for Non Interval Import and Interval Meter Points including Import and the netting of Non Participant Generator Export Data registered to the Supplier Unit , for Indicative D+1, Initial D+4, Reaggregation M+4, Reaggregation M+13 , Ad-Hoc

The Settlement Run Indicator within each message illustrates which aggregation run the message relates to, as follows

10 = Indicative
20 = Initial

Co-Ordinated Retail Market Message Guide – Data Aggregation

30 = 1st ReAggregation at M+4
40 = 2nd ReAggregation at M+13
50 = Ad Hoc Aggregation

Please note the following requirements of SEMO:

- Interval period in which aggregated data is provided to SEMO is Half-hourly
- All Aggregated data for SEMO is provided in MWh and specifically not kWh
- Data is provided per 30-minute Interval for each Supplier Unit.

As such, these requirements result in the following pre-processing steps for each Supplier Unit data:

- Per 15-minute interval, adding the Loss Adjusted Non Interval Import and Interval Import Data that has been summated to Supplier Unit level
- Summate from 15-minutes to 30-minutes settlement interval
- Subtract , per 30-minute settlement interval, the non-participant generation data that has been summated per Supplier Unit from the relevant 30-minute settlement interval for the Loss Adjusted Import that has been aggregated per Supplier Unit
- Convert kWh data to MWh by division by 1000, representing MWh to three decimal places

The loss adjusted aggregated data is provided to the SEMO using message 590 and a copy of aggregated data relevant to a Supplier is provided to that Supplier using message 596.

Reading Data Status field

All SEM settlement statements are required to indicate if the settlement data is estimated or not. The Reading Data Status field in the 590 and 596 messages will either contain an estimated or an actual flag where a code of 0 denotes estimated readings while a code of 1 denotes Actual readings.

In this situation the following is the definition of 'Estimated':

- For each Supplier Unit aggregation D+1, D+4, M+4, M+13, there is a service level agreement for the different percentages of estimated data. Service level targets for meter readings are set and if met then the Supplier Units aggregated data will be marked with an actual flag (1), otherwise an Estimated flag (0), per half hourly interval
- Interval meter data only [ie Interval] and not Non Interval data is considered in arriving at the estimated or actual flag.

Rounding

Rounding for the 596 message is carried out as follows:

- To convert kWh data to MWh by division by 1000, representing MWh to three decimal places
- ESB Networks rounding procedure is that if the value of the 4th decimal place after division by 1000 is 5 or greater then the 3rd decimal place is rounded up by one.

As the proportion of errors are thought to be higher for consumption that is not recorded by profile metering MRSO are obliged to communicate the Non Interval Energy Proportion (NIEP) per settlement period per supplier unit. The NIEP is calculated using the following:

Co-Ordinated Retail Market Message Guide – Data Aggregation

- Total Non Interval Consumption with DLF applied / Total Non Interval and Interval Consumption with DLF applied.
- The calculation is based on values in KWH per 30 minutes. The NIEP value is rounded to 8 decimal places.

The NIEP value will be sent on every new 590 (NPED) and 596 message that is generated after the Global Aggregation go live date.

Message 596 is used in the following Market Process:

Process Number and Title		Use of Message
MPD 16 2.1	Data Aggregation	Meter Data Provider performs Data Aggregation for Non Interval Import and Interval Meter Points including Import and the netting of Non Participant Generator Export Data registered to the Supplier Unit , for Indicative D+1, Initial D+4, Reaggregation M+4, Reaggregation M+13 , Ad-Hoc

Data Hierarchy Diagram

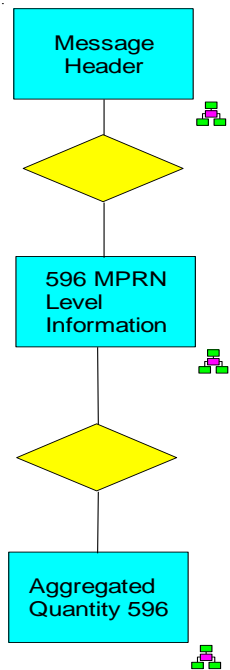

Co-Ordinated Retail Market Message Guide – Data Aggregation

Message Structure and Interpretation

Segment and Field Level Identifier – 596 Message			Rpt	Optionality	Description and Purpose
1	Message Header		1	Mandatory	See Common Data Segments for detailed notes on structure and population.
1	Wholesale Header		1	Mandatory	Only one Supplier Unit is present in the message.
2	FLD	Settlement Run Indicator	1	Mandatory	The Settlement Run Indicator within each message illustrates which aggregation run the message relates to, as follows 10 = Indicative 20 = Initial 30 = 1st ReAggregation at M+4 40 = 2nd ReAggregation at M+13 50 = Ad Hoc Aggregation
2	FLD	Start Period Time	1	Mandatory	Start of Period where reported metered values are measured.
2	FLD	End Period Time	1	Mandatory	End of Period where reported metered values are measured.
2	FLD	End Period Time	1	Mandatory	Creation time of the file
2	FLD	Supplier Unit ID	1	Mandatory	The Supplier Unit ID is an SEM-provided code, created by the SEMO and notified to RMO during registration. Supplier Unit is a wholesale SEM-defined market participant. One Supplier may register several Supplier Units.
2	SEG	Aggregated Quantity	1	Mandatory	Data is present for each Interval Period aggregated for the Settlement

Co-Ordinated Retail Market Message Guide – Data Aggregation

Segment and Field Level Identifier – 596 Message				Rpt	Optionality	Description and Purpose
						Date.
	3	FLD	Reading Number	1	Mandatory	For each meter reading, there will be a reading entry (46, 48, or 50 in total depending on short, normal or long day). The Reading num= value will correspond to the relative period in the day.
	3	FLD	Interval Start Time	1	Mandatory	Local start time for an individual reading (an hour or half-hour value)
	3	FLD	Interval End Time	1	Mandatory	Local end time for an individual reading (a half-hour or hour value, a half hour after the start time)
	3	FLD	Measured Quantity	1	Mandatory	Quantity according to unit on series record. Period is used in fractional numbers, e.g. 12.34 or 0.34. Negative numbers should be prefaced by minus sign, e.g. -12.34 or -0.34. Units are MWhs.
	3	FLD	Query Flag	1	Mandatory	Set to 0
	3	FLD	Reading Data Status	1	Mandatory	0 - Estimated 1 - Actual Comment – see Purpose and Description of Message' above for further details
	3	FLD	NIEP	1	Optional	Shows the percentage of NQH consumption to 8 decimal places

2.5.9 Message 597: SEMO Aggregated DATA (Gen UNIT, 30-min, MWh)

Purpose and Description of Message

Message 597 is sent by the Meter Data Provider to the Participant generator to advise what has been sent to the SEMO in a 590 message from each aggregation run. There is a separate message 597 for each **Participant Generator Unit** that has been included in each 590 message and which is registered to the Participant generator. The 597 contains Data Aggregation of Interval Export for Participant Interval Meter Points for the Settlement Date.

Participant Generator messages that are sent to a Supplier will now carry a Recipient ID of the nominated Supplier

The Settlement Run Indicator within each message illustrates which aggregation run the message relates to, as follows

- 10 = Indicative
- 20 = Initial
- 30 = 1st ReAggregation at M+4
- 40 = 2nd ReAggregation at M+13
- 50 = Ad Hoc Aggregation

Please note the following requirements of SEMO:

- Interval period in which aggregated data is provided to SEMO is Half-hourly
- All Aggregated data for SEMO is provided in MWh and specifically not kWh
- Generator data is not signed, Import data is signed as negative
- Data is provided per 30-minute Interval for each Participant Generator Unit.

As such, these requirements result in the following pre-processing steps for each **Participant Generator Unit** data:

- Per 15-minute interval, summate from 15-minutes to 30-minutes settlement interval the loss adjusted Export kWh generation.
- Convert kWh data to MWh by division by 1000, representing MWh to three decimal places

The loss adjusted aggregated data is provided to the SEMO using message 590. A copy of aggregated data relevant to a Participant Generator is provided to that Participant Generator using message 597.

Reading Data Status field

Co-Ordinated Retail Market Message Guide – Data Aggregation

All SEM settlement statements are required to indicate if the settlement data is estimated or not. The Reading Data Status field in the 590 and 597 messages will either contain an estimated or an actual flag where a code of 0 denotes estimated readings while a code of 1 denotes Actual readings.

Rounding

Rounding for the 597 message is carried out as follows:

- To convert kWh data to MWh by division by 1000, representing MWh to three decimal places
- ESB Networks rounding procedure is that if the value of the 4th decimal place after division by 1000 is 5 or greater then the 3rd decimal place is rounded up by one.

Message 597 is used in the following Market Process:

Process Number and Title		Use of Message
MPD 16 2.1	Data Aggregation	Meter Data Provider performs Data Aggregation for Participant Generator Export Data for Indicative D+1, Initial D+4, Reaggregation M+4, Reaggregation M+13 , Ad-Hoc

Data Hierarchy Diagram

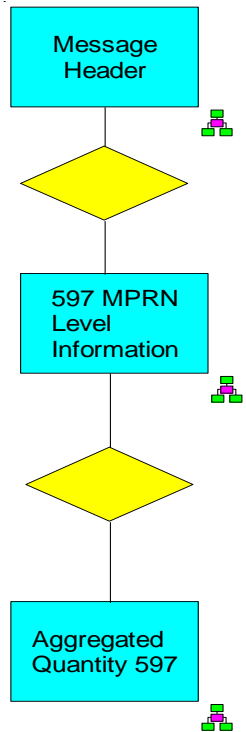

Co-Ordinated Retail Market Message Guide – Data Aggregation

Message Structure and Interpretation

Segment and Field Level Identifier – 597 Message			Rpt	Optionality	Description and Purpose
1	Message Header		1	Mandatory	See Common Data Segments for detailed notes on structure and population.
1	Wholesale Header		1	Mandatory	Only one Participant generator Unit is present in the message.
2	FLD	Settlement Run Indicator	1	Mandatory	The Settlement Run Indicator within each message illustrates which aggregation run the message relates to, as follows 10 = Indicative 20 = Initial 30 = 1st ReAggregation at M+4 40 = 2nd ReAggregation at M+13 50 = Ad Hoc Aggregation
2	FLD	Start Period Time	1	Mandatory	Start of Period where reported metered values are measured.
2	FLD	End Period Time	1	Mandatory	End of Period where reported metered values are measured.
2	FLD	End Period Time	1	Mandatory	Creation time of the file

Co-Ordinated Retail Market Message Guide – Data Aggregation

Segment and Field Level Identifier – 597 Message			Rpt	Optionality	Description and Purpose
2	FLD	Generation Unit ID	1	Mandatory	Participant Generator Unit ID
2	SEG	Aggregated Quantity	1	Mandatory	Data is present for each Interval Period aggregated for the Settlement Date.
3	FLD	Reading Number	1	Mandatory	For each meter reading, there will be a reading entry (46, 48, or 50 in total depending on short, normal or long day). The Reading num= value will correspond to the relative period in the day.
3	FLD	Interval Start Time	1	Mandatory	Local start time for an individual reading (an hour or half-hour value)
3	FLD	Interval End Time	1	Mandatory	Local end time for an individual reading (a half-hour or hour value, a half hour after the start time)
3	FLD	Measured Quantity	1	Mandatory	Quantity according to unit on series record. Period is used in fractional numbers, e.g. 12.34 or 0.34. Negative numbers should be prefaced by minus sign, e.g. -12.34 or -0.34. Units are MWhs.
3	FLD	Query Flag	1	Mandatory	Set to 0
3	FLD	Reading Data Status	1	Mandatory	0 - Estimated 1 - Actual