

## 252 Request for Special Reading

### 252 Valid Codes

#### Read Type

**A** – denoting that an actual reading is required

**E** - denoting that an estimated reading is required for Change of Supplier only. This setting may only be used with a Read Reason of 04.

#### Read Reason

**04** – denoting that a special reading is required to dispute a previous reading

**02** – denoting a chargeable special reading that is required for any reason other than a dispute.

#### Request Status

**I** – to initiate the request

**W** – to withdraw the request

#### Please Note:

#### Required Date

If an Actual Read is to be collected on a specific day then this date should be provided here. At least five working days notice is required. If this field is omitted then the Data Collector will schedule the reading within the following five days in accordance with service levels (*to be agreed*).

If an Estimate is required to settle a dispute then this date should be set to the date of the reading being disputed.

#### Access Arrangements

Text may be provided to describe any special arrangements required for access to the meters. It is recommended that sufficient detail is provided to enable the customer to be contacted as visits that do not result in the collection of a reading may still be chargeable.

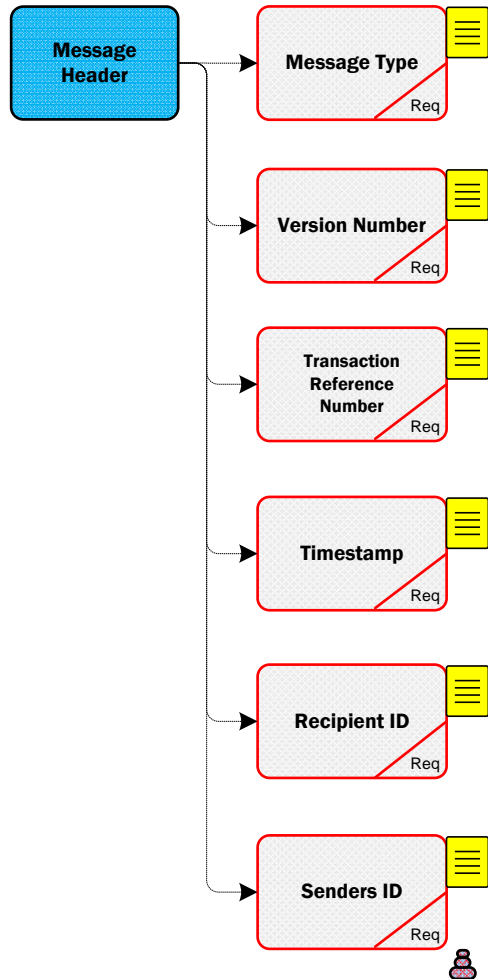

**252 MPRN Level Info**

**MPRN**  
Req

**Access Arrangements**  
Opt

**Market Participant Business Reference**  
Req

**Supplier ID**  
Req

**Read Type**  
Req

**Read Reason**  
Req

**Request Status**  
Req

**Required Date**  
Opt



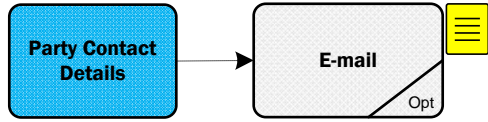

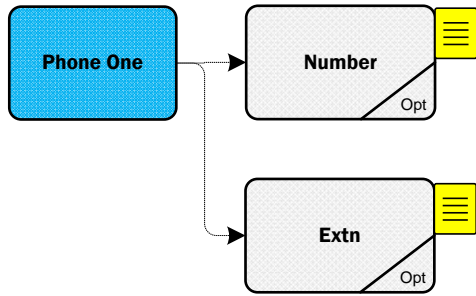

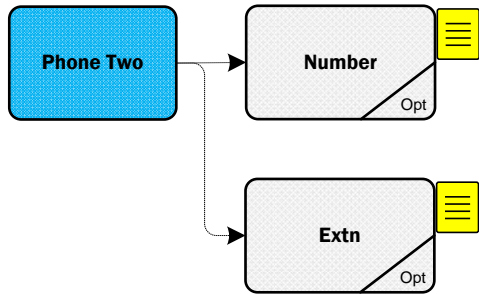

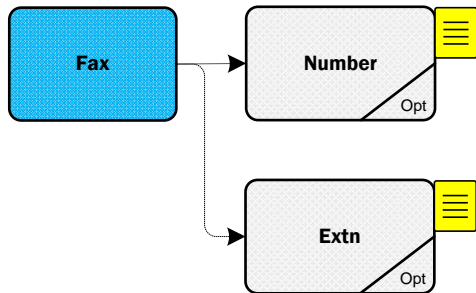



**Senders  
ID**

**Click Here for Latest  
Senders ID  
List**

**Supplier  
ID**

**Click Here for Latest  
Supplier ID  
List**

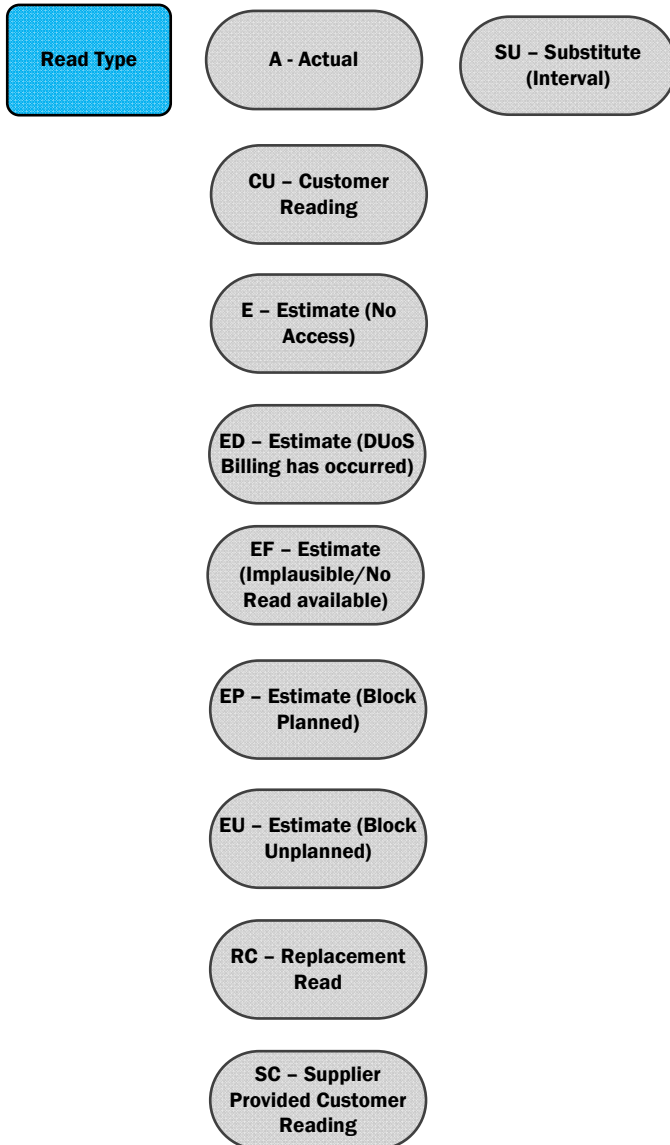

### Read Reason

01 - Scheduled

17 - Change of Profile

95 - Not for CoS

02 - Special Read, Chargeable

18 - Energisation

04 - Special Read to resolve dispute

21 - Start Reading ( New Register)

09 - Special Read, non chargeable

22 - Closing Reading (Register removed)

10 - Ad-hoc, no chargeable check read

23 - Meter Works Single reading

11 - Start reading after meter re-programming

26 - Change of Supplier

13 - De-Energisation

27 - Change of Legal Entity

14 - Estimate

28 - Closing read before register re-number

16 - Closing read before meter re-programming

29 - Star read after register re-number



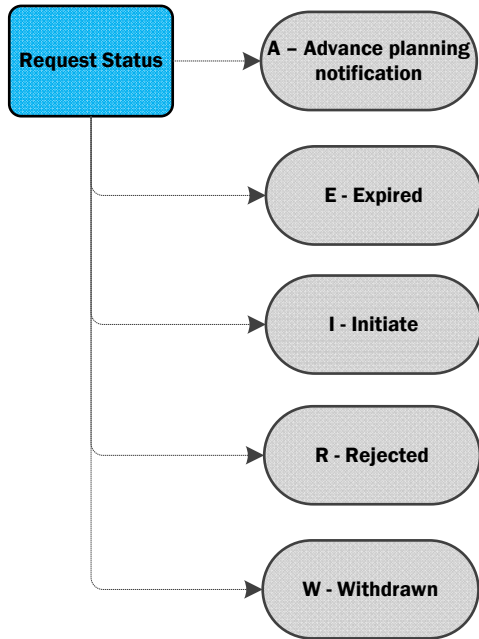



## 252 Request for Special Reading

Version Which Implemented	Source of Change	Description of Change
10.4	MCR 1155	Message format changed from ARIS to Document format.