

101R New Registration Rejection

101R Valid Codes

Reject Reason

AMM – The Meter Point Address on the message does not match that held by DSO for the MPRN

IGU – The Generation Unit ID on the message does not match that held for the MPRN

IMP – The MPRN does not exist or is for a Grouped Un-metered site (either at GMPRN or TMPRN level)

IMS – The MPRN status is not Assigned, Energised or De-energised.

NSA – The Supplier has not warranted that a Supply Agreement exists

RP – Another Supplier has submitted a registration for this MPRN

SNK – The Supplier Id is not known

SSS – SSAC is not allowed for use by the Supplier or for the Settlement Class of the Meter Point

IEA – Invalid / incomplete EAI code

Please Note: The 010 message can also be rejected for invalid / incomplete Data in the scenarios as indicated below

IID – The Customer is a Person but the request did not include a Customer Last Name

IID – The Customer is an Organisation but the request did not include a Customer Name Org_1

IID – Customer Name details provided contained a mixture of Person and Organisation fields

IID – A User rejected the request because data was invalid or incomplete

DIJ - Data invalid for jurisdiction(Added for Harmonisation V10.0

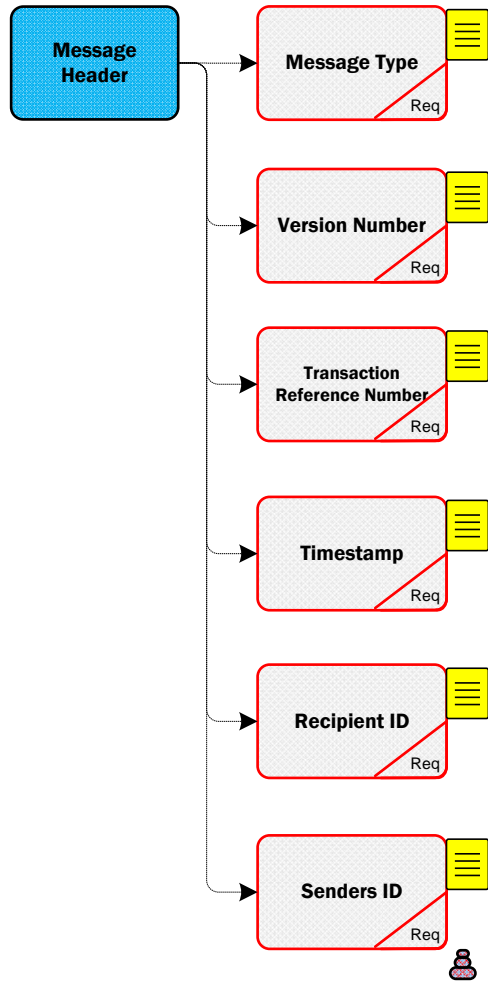

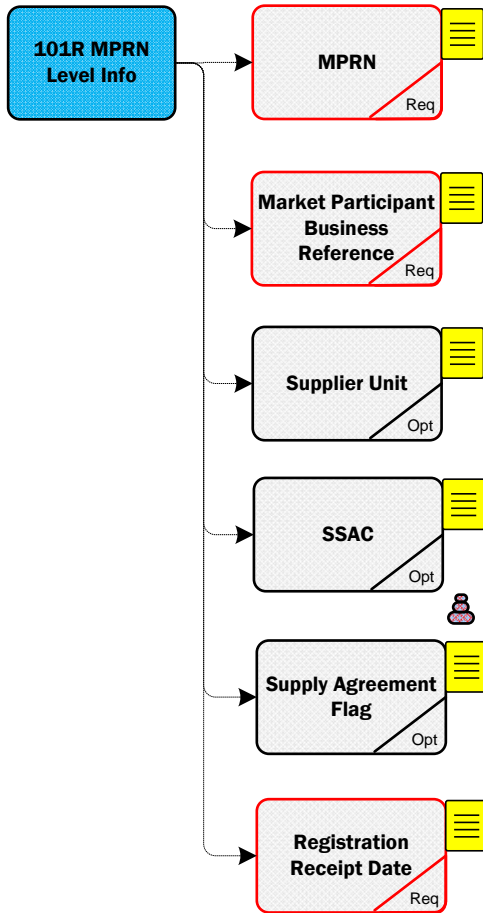



Meter Point Address



Unit No. 
Opt

Postal Code 
Opt



Addr Line 1 
Opt

City 
Opt

Addr Line 2 
Opt

County Ireland 
Opt 

House No. 
Opt

Country 
Opt 

Street 
Opt

Addr Line 4 
Opt

Addr Line 5 
Opt

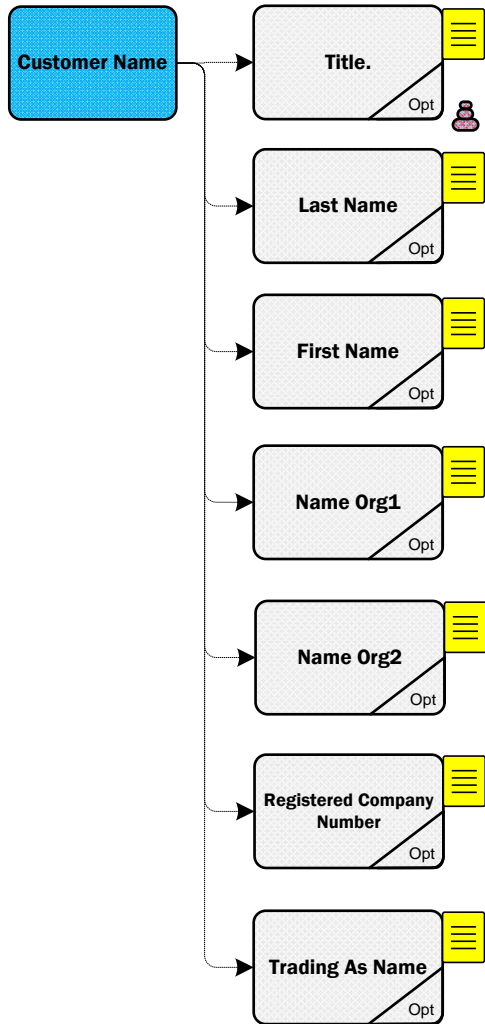

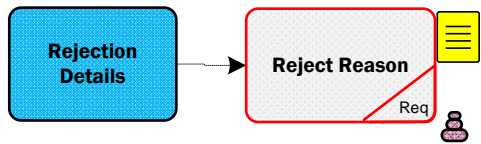

**Senders
ID**

**Click Here for Latest
Senders ID
List**

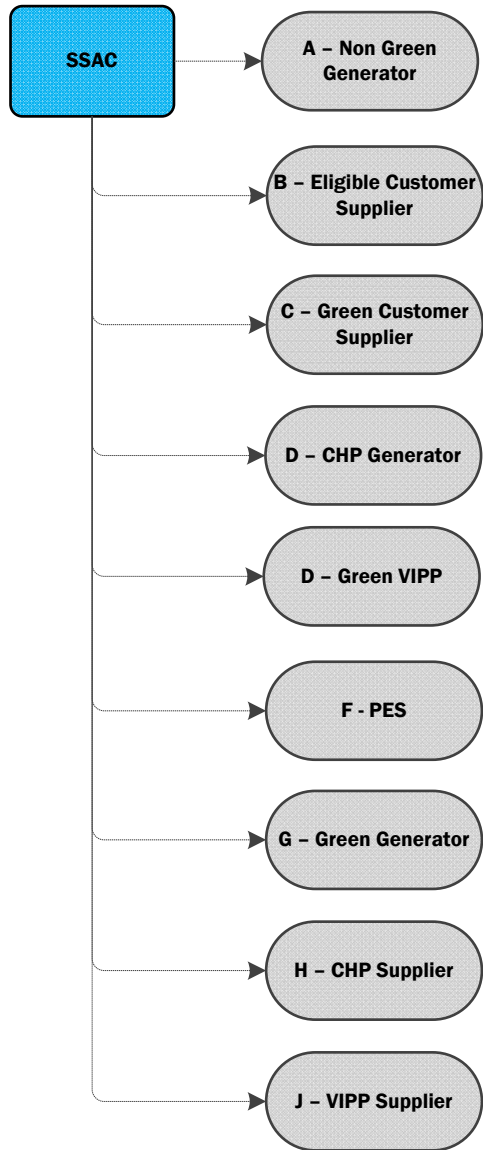

101R New Registration Rejection

Code

County
Ireland

AM	Armagh	LK	Limerick	ZA	BHAILE ATHA CLIATHA	ZN	LIATROMA
AT	Antrim	LM	Leitrim	ZB	AN CHABHAIN	ZO	LOCH GARMAN
CE	Clare	LS	Laois	ZC	CHEATHARLACH	ZP	AN LONGFOIRT
CK	Cork	LY	Londonderry	ZD	CHIARRAI	ZQ	LU
CN	Cavan	MH	Meath	ZE	CHILL CHAINNIGH	ZR	LUIMNIGH
CW	Carlow	MN	Monaghan	ZF	CHILL DARA	ZS	MHAIGH EO
DB	Dublin	MO	Mayo	ZG	CHILL MHANTAIN	ZT	NA MI
DE	Derry	OY	Offaly	ZH	AN CHLAIR	ZU	MHUINEACHAIN
DL	Donegal	RN	Roscommon	ZI	CHORCAI	ZV	PHORT LAIRGE
DN	Down	SO	Sligo	ZJ	DHUN NA NGALL	ZW	ROS COMAIN
FM	Fermanagh	TP	Tipperary	ZK	NA GAILLIMHE	ZX	SHLIGIGH
GW	Galway	TY	Tyrone	ZL	NA HIARMHI	ZY	THIOBRAID ARANN
KE	Kildare	WD	Waterford	ZM	LAOISE	ZZ	UIBH FHAILI
KK	Kilkenny	WH	Westmeath				
KY	Kerry	WW	Wicklow				
LD	Longford	WX	Wexford				
LH	Louth						

Message

Meter Point Address

RMDS RETAIL MARKET DESIGN SERVICE

County Ireland

101R New Registration Rejection

Code

Country

AD	Andorra	CA	Canada	FO	Faroe Islands	JM	Jamaica	MP	N.Mariana Islnd	PW	Palau	TO	Tonga
AE	UAE	CC	Coconut Islands	FR	France	JO	Jordan	MQ	Martinique	PY	Paraguay	TP	East Timor
AF	Afghanistan	CD	Congo	GA	Gabon	JP	Japan	MR	Mauretania	QA	Qatar	TR	Turkey
AG	Antigua/Barbuda	CF	Central Afr.Rep	GB	United Kingdom	KE	Kenya	MS	Montserrat	RE	Reunion	TT	Trinidad,Tobago
AI	Anguilla	CG	Congo	GD	Grenada	KG	Kyrgyzstan	MT	Malta	RO	Romania	TV	Tuvalu
AL	Albania	CH	Sw itzerland	GE	Georgia	KH	Cambodia	MU	Mauritius	RU	Russian Fed.	TW	Taiw an
AM	Armenia	CI	Ivory Coast	GF	French Guayana	KI	Kiribati	MV	Maldives	RW	Rw anda	TZ	Tanzania
AN	Dutch Antilles	CK	Cook Islands	GH	Ghana	KM	Comoros	MW	Malaw i	SA	Saudi Arabia	UA	Ukraine
AO	Angola	CL	Chile	GI	Gibraltar	KN	St Kitts&Nevis	MX	Mexico	SB	Solomon Islands	UG	Uganda
AQ	Antarctica	CM	Cameroon	GL	Greenland	KP	North Korea	MY	Malaysia	SC	Seychelles	UM	Minor Outl.Isl.
AR	Argentina	CN	China	GM	Gambia	KR	South Korea	MZ	Mozambique	SD	Sudan	US	USA
AS	Samoa, American	CO	Colombia	GN	Guinea	KW	Kuw ait	NA	Namibia	SE	Sw eden	UY	Uruguay
AT	Austria	CR	Costa Rica	GP	Guadeloupe	KY	Cayman Islands	NC	New Caledonia	SG	Singapore	UZ	Uzbekistan
AU	Australia	CU	Cuba	GQ	Equatorial Gui.	KZ	Kazakhstan	NE	Niger	SH	St. Helena	VA	Vatican City
AW	Aruba	CV	Cape Verde	GR	Greece	LA	Laos	NF	Norfolk Island	SI	Slovenia	VC	St. Vincent
AZ	Azerbaijan	CX	Christmas Islnd	GS	Sth Sandw ich Is	LB	Lebanon	NG	Nigeria	SJ	Svalbard	VE	Venezuela
BA	Bosnia-Herz.	CY	Cyprus	GT	Guatemala	LC	St. Lucia	NI	Nicaragua	SK	Slovakia	VG	Brit.Virgin Is.
BB	Barbados	CZ	Czech Republic	GU	Guam	LI	Liechtenstein	NL	Netherlands	SL	Sierra Leone	VI	Amer.Virgin Is.
BD	Bangladesh	DE	Germany	GW	Guinea-Bissau	LK	Sri Lanka	NO	Norw ay	SM	San Marino	VN	Vietnam
BE	Belgium	DJ	Djibouti	GY	Guyana	LR	Liberia	NP	Nepal	SN	Senegal	VU	Vanuatu
BF	Burkina-Faso	DK	Denmark	HK	Hong Kong	LS	Lesotho	NR	Nauru	SO	Somalia	WF	Wallis, Futuna
BG	Bulgaria	DM	Dominica	HM	Heard/McDon.Isl	LT	Lithuania	NU	Niue Islands	SR	Suriname	WS	Western Samoa
BH	Bahrain	DO	Dominican Rep.	HN	Honduras	LU	Luxembourg	NZ	New Zealand	ST	S.Tome,Principe	YE	Yemen
BI	Burundi	DZ	Algeria	HR	Croatia	LV	Latvia	OM	Oman	SV	El Salvador	YT	Mayotte
BJ	Benin	EC	Ecuador	HT	Haiti	LY	Libya	PA	Panama	SY	Syria	YU	Yugoslavia
BM	Bermuda	EE	Estonia	HU	Hungary	MA	Morocco	PE	Peru	SZ	Sw aziland	ZA	South Africa
BN	Brunei	EG	Egypt	ID	Indonesia	MC	Monaco	PF	Frenc.Polynesia	TC	Turksh Caicosin	ZM	Zambia
BO	Bolivia	EH	West Sahara	IE	Ireland	MD	Moldavia	PG	Pap. New Guinea	TD	Chad	ZW	Zimbabw e
BR	Brazil	ER	Eritrea	IL	Israel	MG	Madagascar	PH	Philippines	TF	French S.Territ		
BS	Bahamas	ES	Spain	IN	India	MH	Marshall Islnds	PK	Pakistan	TG	Togo		
BT	Bhutan	ET	Ethiopia	IO	Brit.Ind.Oc.Ter	MK	Macedonia	PL	Poland	TH	Thailand		
BV	Bouvet Island	FI	Finland	IQ	Iraq	ML	Mali	PM	St.Pier,Miquel.	TJ	Tajikstan		
BW	Botsw ana	FJ	Fiji	IR	Iran	MM	Myanmar	PN	Pitcairn Islnds	TK	Tokelau Islands		
BY	Belarus	FK	Falkland Islnds	IS	Iceland	MN	Mongolia	PR	Puerto Rico	TM	Turkmenistan		
BZ	Belize	FM	Micronesia	IT	Italy	MO	Macau	PT	Portugal	TN	Tunisia		

Message

Meter Point Address

RMDS RETAIL MARKET DESIGN SERVICE

Country

101R New Registration Rejection

Code

Title

Br - Brother

Msgr - Monsignor

Cllr - Councillor

Ms - Ms

Dr - Doctor

Prof - Professor

Fr - Father

Rec - Reverend

Lady - Lady

Sir - Sir

Lord - Lord

Sr - Sister

Miss - Miss

Mr - Mr

Mrs - Mrs

Message

Customer Name

RMDS RETAIL MARKET DESIGN SERVICE

Title

101R New Registration Rejection

Code

Reject Reason

AGU	Invalid Generation unit	IDT	Invalid date or time	IRS	Invalid register sequence	SAR	Supplier already registered
AMM	Address does not match MPRN	IEA	Invalid/Incomplete EAI Code	IRT	Invalid read type	SNK	Supplier not known
CAN	Cancellation not agreed	IGA	Invalid or missing GUAC	ITI	Invalid timeslot	SNR	Supplier Not registered to MPRN
CIP	CoS in progress	IGU	Invalid Generation unit data	IUM	Invalid unit of measure	SSN	SSAC Not Known
COL	Change of Legal Entity in progress	IID	Invalid/Incomplete data	LO	Lock Out	SSS	SSAC is invalid for the supplier unit
COS	CoS Effective < 20 days	IMF	Invalid Meter Configuration code	LOC	Supplier of Last Resort lock in	SUN	Supplier Unit Not known
CUG	Customer Usage	IMP	Invalid MPRN	MIC	MIC Change detected	SUS	Supplier Unit invalid for Supplier
DIJ	Data Invalid for Jurisdiction	IMS	Invalid MPRN status	MWO	Open Meter Works Order	TIM	Outside Timescale
DSO	DSO rejected request	IMT	Invalid meter ID	NQE	Not Interval Eligible	TMP	Terminated MPRN
IA	Invalid Action	IRA	Invalid read arrangement	NRC	No reason code	TSR	Trading Site Supplier Unit Rejected
ICD	Invalid change of Meter point address	IRC	Invalid reason code	NRS	No Register Sequence Number	VUL	Vulnerable Customer
ICE	Invalid CoS Estimate Acceptable	IRP	Invalid Register Type	NSA	No Supply Agreement		
ICL	Implied CoLE	IRQ	Invalid request status	QHM	Interval Meter Point		
ICU	Invalid Change of Customer Usage	IRR	Invalid read reason	RP	Registration in progress		

Message

Rejection Details

Reject Reason

101R New Registration Rejection

Version Which Implemented	Source of Change	Description of Change
10.4	MCR 1155	Message format changed from ARIS to Document format.