

017 Meter Point Status Change Request

017 Valid Codes

Meter Point Status

D or E only

Request Status

I or W only

Please Note: Request status should only be set to W where a previous 017 has been sent and no confirmation of site works has been received back, (306 / 307 and 106E / 106D messages) and Supplier wishes to cancel that previous instruction. 017 withdrawn me

Optional/Mandatory; Although the following Data Items are optional, note the following caveats:-

Supply Agreement Flag: Mandatory if there is a change of Tenant or Legal Entity

Access Instructions: Ignored if no change of Tenant and Legal Entity

Economic Activity Code: Ignored if no change of Tenant and Legal Entity

Required Date: If omitted a date as soon as possible is assumed

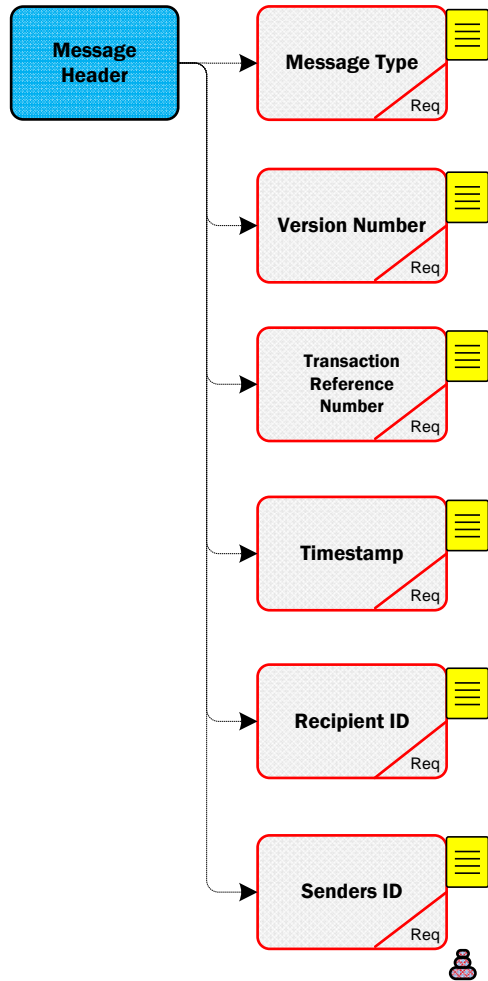

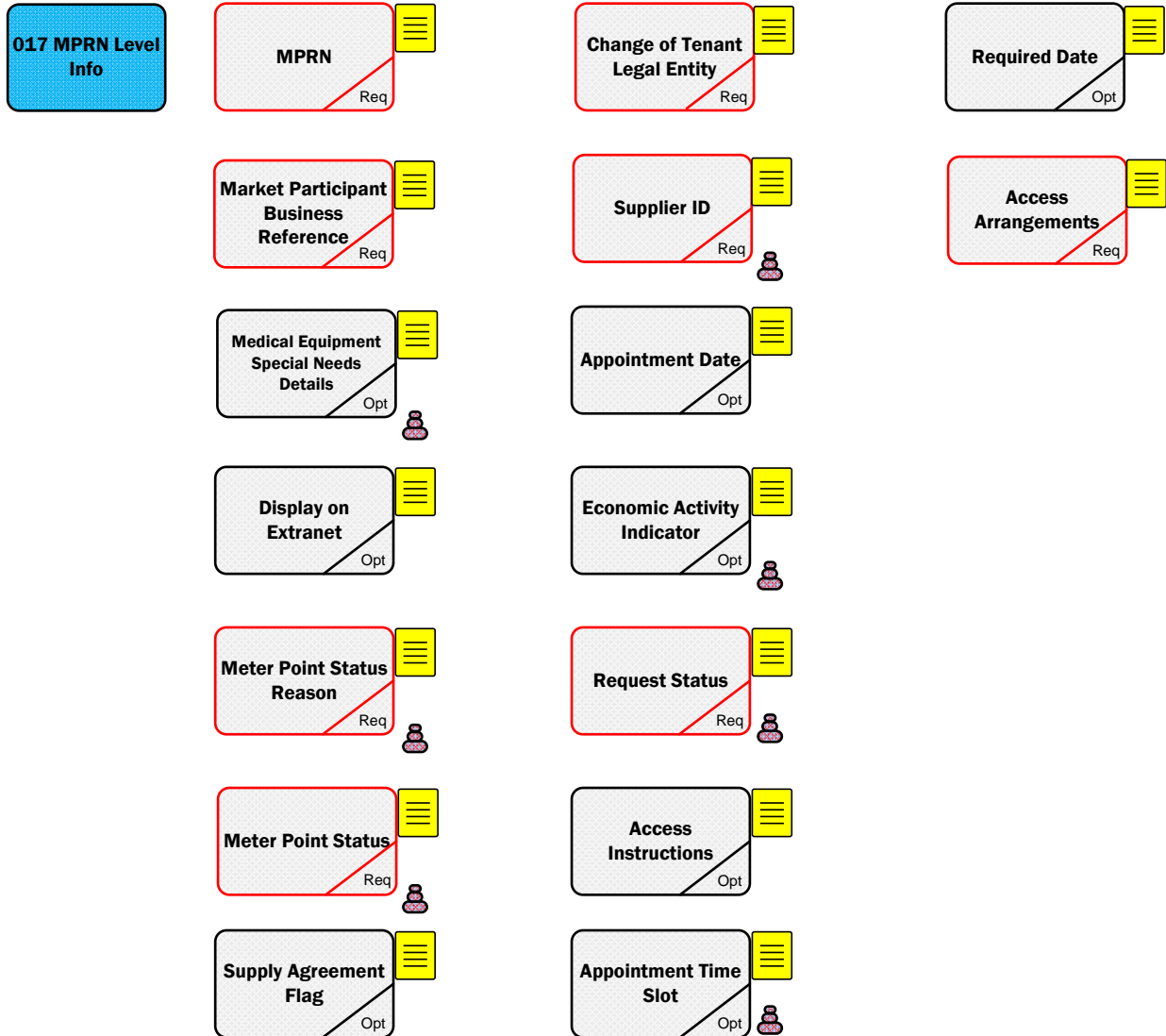

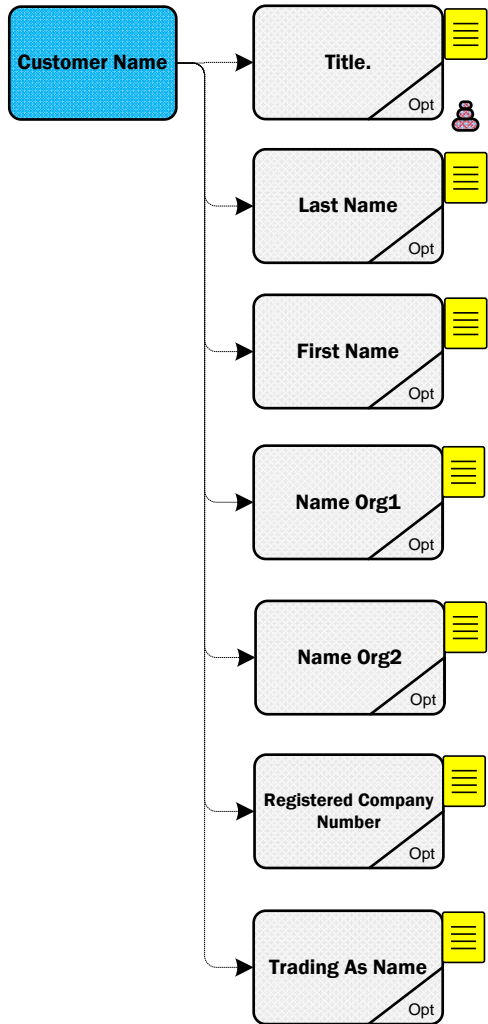

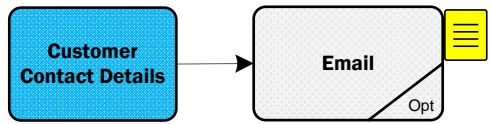

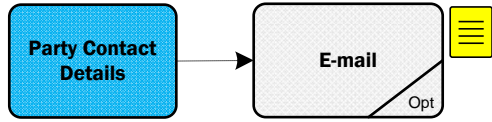

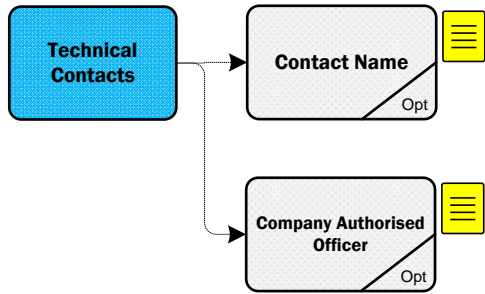

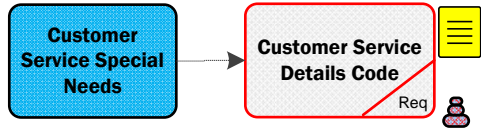

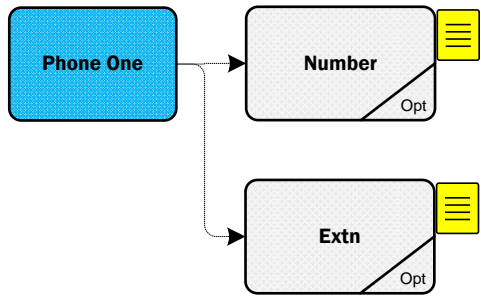

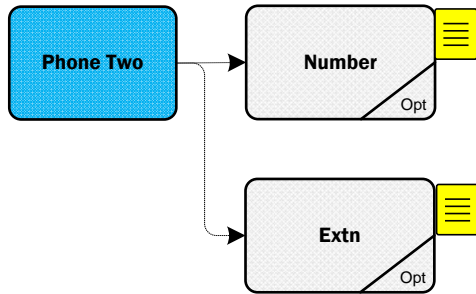

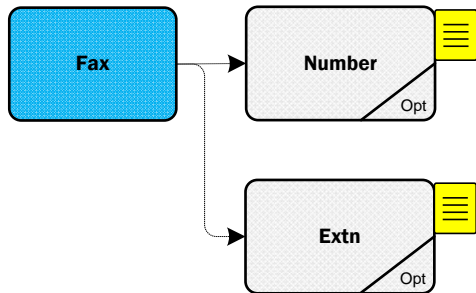

Address

C/O Name
Opt

Addr Line 5
Opt

Unit No.
Opt

Postal Code
Opt

Addr Line 1
Opt

City
Opt

Addr Line 2
Opt

County Ireland
Opt

House No.
Opt

County/State
Opt

Street
Req

Country
Opt

Addr Line 4
Opt

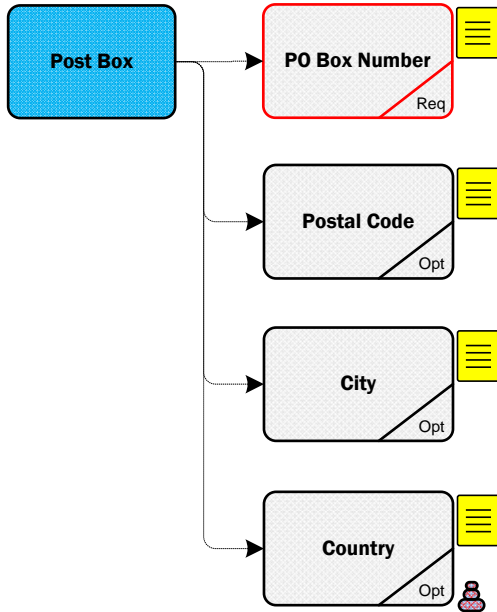

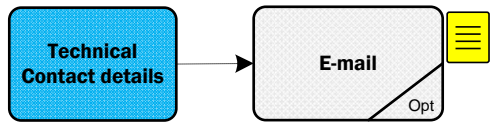

**Senders
ID**

**Click Here for Latest
Senders ID
List**

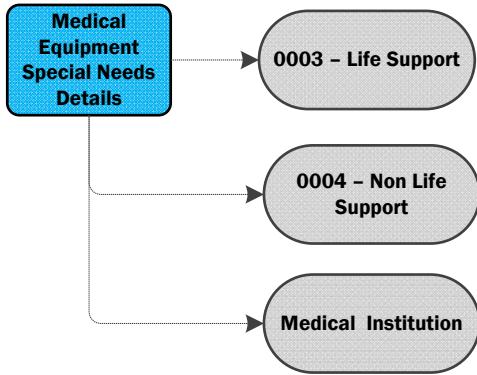

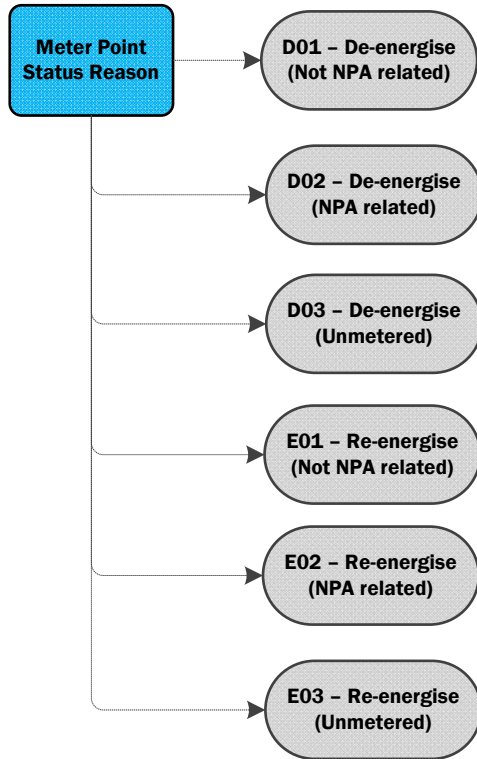

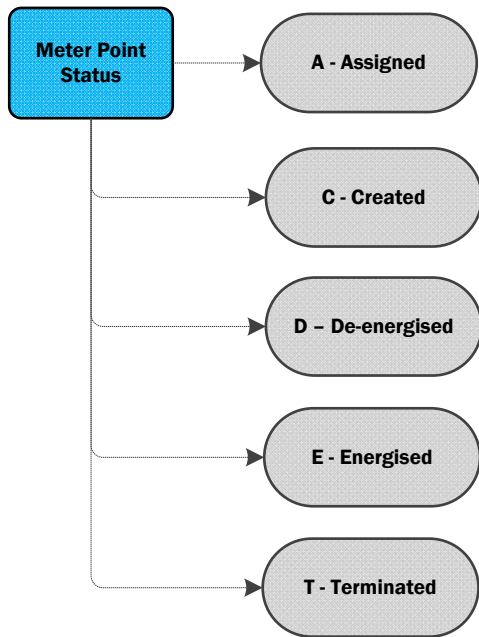

**Supplier
ID**

**Click Here for Latest
Supplier ID
List**

017 Meter Point Status Change Request

Code

Economic Activity Indicator

01	Agriculture, hunting and related service activities	28	Manufacture of fabricated metal products, except machinery and equipment	64	Post and telecommunications
02	Forestry, logging and related service activities	29	Manufacture of machinery and equipment n.e.c.	65	Financial intermediation, except insurance and pension funding
05	Fishing, fish farming and related service activities	30	Manufacture of office machinery and computers	66	Insurance and pension funding, except compulsory social security
10	Mining of coal and lignite; extraction of peat	31	Manufacture of electrical machinery and apparatus n.e.c.	67	Activities auxiliary to financial intermediation
11	Extraction of crude petroleum and natural gas; service activities incidental to oil and gas extraction, excluding surveying	32	Manufacture of radio, television and communication equipment and apparatus	70	Real estate activities
12	Mining of uranium and thorium ores	33	Manufacture of medical, precision and optical instruments, watches and clocks	71	Renting of machinery and equipment without operator and of personal and household goods
13	Mining of metal ores	34	Manufacture of motor vehicles, trailers and semi-trailers	72	Computer and related activities
14	Other mining and quarrying	35	Manufacture of other transport equipment	73	Research and development
15	Manufacture of food products and beverages	36	Manufacture of furniture; manufacturing n.e.c.	74	Other business activities
16	Manufacture of tobacco products	37	Recycling	75	Public administration and defence; compulsory social security
17	Manufacture of textiles	40	Electricity, gas, steam and hot water supply	80	Education
18	Manufacture of wearing apparel; dressing and dyeing of fur	41	Collection, purification and distribution of water	85	Health and social work
19	Tanning and dressing of leather; manufacture of luggage, handbags, saddlery, harness and footwear	45	Construction	90	Sewage and refuse disposal, sanitation and similar activities
20	Manufacture of wood and of products of wood and cork, except furniture; manufacture of articles of straw and plaiting materials	50	Sale, maintenance and repair of motor vehicles and motorcycles; retail sale of automotive fuel	91	Activities of membership organizations n.e.c.
21	Manufacture of pulp, paper and paper products	51	Wholesale trade and commission trade, except of motor vehicles and motorcycles	92	Recreational, cultural and sporting activities
22	Publishing, printing and reproduction of recorded media	52	Retail trade, except of motor vehicles and motorcycles; repair of personal and household goods	93	Other service activities
23	Manufacture of coke, refined petroleum products and nuclear fuel	55	Hotels and restaurants	95	Activities of households as employers of domestic staff
24	Manufacture of chemicals and chemical products	60	Land transport; transport via pipelines	96	Undifferentiated goods producing activities of private households for own use
25	Manufacture of rubber and plastic products	61	Water transport	97	Undifferentiated services producing activities of private households for own use
26	Manufacture of other non-metallic mineral products	62	Air transport	98	Domestic
27	Manufacture of basic metals	63	Supporting and auxiliary transport activities; activities of travel agencies	99	Extra-territorial organizations and bodies

Message

MPRN Level Information

RMDS RETAIL MARKET DESIGN SERVICE

Economic Activity Indicator

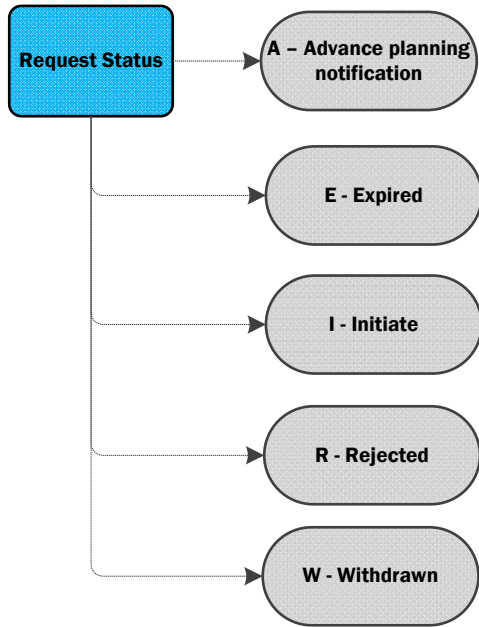

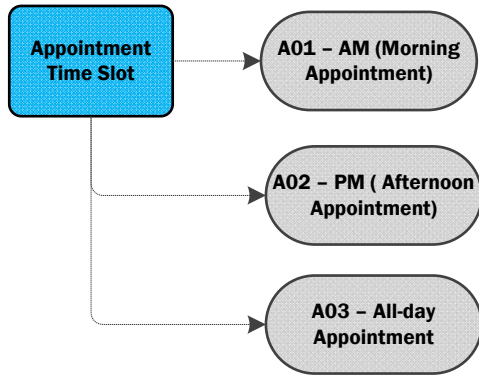

017 Meter Point Status Change Request

Code

Title

Br - Brother

Msgr - Monsignor

Cllr - Councillor

Ms - Ms

Dr - Doctor

Prof - Professor

Fr - Father

Rec - Reverend

Lady - Lady

Sir - Sir

Lord - Lord

Sr - Sister

Miss - Miss

Mr - Mr

Mrs - Mrs

Message

Customer Name

RMDS RETAIL MARKET DESIGN SERVICE

Title

017 Meter Point Status Change Request

Code

County
Ireland

AM	Armagh	LK	Limerick	ZA	BHAILE ATHA CLIATHA	ZN	LIATROMA
AT	Antrim	LM	Leitrim	ZB	AN CHABHAIN	ZO	LOCH GARMAN
CE	Clare	LS	Laois	ZC	CHEATHARLACH	ZP	AN LONGFOIRT
CK	Cork	LY	Londonderry	ZD	CHIARRAI	ZQ	LU
CN	Cavan	MH	Meath	ZE	CHILL CHAINNIGH	ZR	LUIMNIGH
CW	Carlow	MN	Monaghan	ZF	CHILL DARA	ZS	MHAIGH EO
DB	Dublin	MO	Mayo	ZG	CHILL MHANTAIN	ZT	NA MI
DE	Derry	OY	Offaly	ZH	AN CHLAIR	ZU	MHUINEACHAIN
DL	Donegal	RN	Roscommon	ZI	CHORCAI	ZV	PHORT LAIRGE
DN	Dow n	SO	Sligo	ZJ	DHUN NA NGALL	ZW	ROS COMAIN
FM	Fermanagh	TP	Tipperary	ZK	NA GAILLIMHE	ZX	SHLIGIGH
GW	Galw ay	TY	Tyrone	ZL	NA HIARMHI	ZY	THIOBRAID ARANN
KE	Kildare	WD	Waterford	ZM	LAOISE	ZZ	UIBH FHAILI
KK	Kilkenny	WH	Westmeath				
KY	Kerry	WW	Wicklow				
LD	Longford	WX	Wexford				
LH	Louth						

Message

Address

RMDS RETAIL MARKET DESIGN SERVICE

County Ireland

017 Meter Point Status Change Request

Code

Country

AD	Andorra	CA	Canada	FO	Faroe Islands	JM	Jamaica	MP	N.Mariana Islnd	PW	Palau	TO	Tonga
AE	UAE	CC	Coconut Islands	FR	France	JO	Jordan	MQ	Martinique	PY	Paraguay	TP	East Timor
AF	Afghanistan	CD	Congo	GA	Gabon	JP	Japan	MR	Mauretania	QA	Qatar	TR	Turkey
AG	Antigua/Barbuda	CF	Central Afr.Rep	GB	United Kingdom	KE	Kenya	MS	Montserrat	RE	Reunion	TT	Trinidad,Tobago
AI	Anguilla	CG	Congo	GD	Grenada	KG	Kyrgyzstan	MT	Malta	RO	Romania	TV	Tuvalu
AL	Albania	CH	Sw itzerland	GE	Georgia	KH	Cambodia	MU	Mauritius	RU	Russian Fed.	TW	Taiw an
AM	Armenia	CI	Ivory Coast	GF	French Guayana	KI	Kiribati	MV	Maldives	RW	Rw anda	TZ	Tanzania
AN	Dutch Antilles	CK	Cook Islands	GH	Ghana	KM	Comoros	MW	Malaw i	SA	Saudi Arabia	UA	Ukraine
AO	Angola	CL	Chile	GI	Gibraltar	KN	St Kitts&Nevis	MX	Mexico	SB	Solomon Islands	UG	Uganda
AQ	Antarctica	CM	Cameroon	GL	Greenland	KP	North Korea	MY	Malaysia	SC	Seychelles	UM	Minor Outl.Isl.
AR	Argentina	CN	China	GM	Gambia	KR	South Korea	MZ	Mozambique	SD	Sudan	US	USA
AS	Samoa, American	CO	Colombia	GN	Guinea	KW	Kuw ait	NA	Namibia	SE	Sw eden	UY	Uruguay
AT	Austria	CR	Costa Rica	GP	Guadeloupe	KY	Cayman Islands	NC	New Caledonia	SG	Singapore	UZ	Uzbekistan
AU	Australia	CU	Cuba	GQ	Equatorial Gui.	KZ	Kazakhstan	NE	Niger	SH	St. Helena	VA	Vatican City
AW	Aruba	CV	Cape Verde	GR	Greece	LA	Laos	NF	Norfolk Island	SI	Slovenia	VC	St. Vincent
AZ	Azerbaijan	CX	Christmas Islnd	GS	Sth Sandw ich Is	LB	Lebanon	NG	Nigeria	SJ	Svalbard	VE	Venezuela
BA	Bosnia-Herz.	CY	Cyprus	GT	Guatemala	LC	St. Lucia	NI	Nicaragua	SK	Slovakia	VG	Brit.Virgin Is.
BB	Barbados	CZ	Czech Republic	GU	Guam	LI	Liechtenstein	NL	Netherlands	SL	Sierra Leone	VI	Amer.Virgin Is.
BD	Bangladesh	DE	Germany	GW	Guinea-Bissau	LK	Sri Lanka	NO	Norw ay	SM	San Marino	VN	Vietnam
BE	Belgium	DJ	Djibouti	GY	Guyana	LR	Liberia	NP	Nepal	SN	Senegal	VU	Vanuatu
BF	Burkina-Faso	DK	Denmark	HK	Hong Kong	LS	Lesotho	NR	Nauru	SO	Somalia	WF	Wallis, Futuna
BG	Bulgaria	DM	Dominica	HM	Heard/McDon.Isl	LT	Lithuania	NU	Niue Islands	SR	Suriname	WS	Western Samoa
BH	Bahrain	DO	Dominican Rep.	HN	Honduras	LU	Luxembourg	NZ	New Zealand	ST	S.Tome,Principe	YE	Yemen
BI	Burundi	DZ	Algeria	HR	Croatia	LV	Latvia	OM	Oman	SV	El Salvador	YT	Mayotte
BJ	Benin	EC	Ecuador	HT	Haiti	LY	Libya	PA	Panama	SY	Syria	YU	Yugoslavia
BM	Bermuda	EE	Estonia	HU	Hungary	MA	Morocco	PE	Peru	SZ	Sw aziland	ZA	South Africa
BN	Brunei	EG	Egypt	ID	Indonesia	MC	Monaco	PF	Frenc.Polynesia	TC	Turksh Caicosin	ZM	Zambia
BO	Bolivia	EH	West Sahara	IE	Ireland	MD	Moldavia	PG	Pap. New Guinea	TD	Chad	ZW	Zimbabw e
BR	Brazil	ER	Eritrea	IL	Israel	MG	Madagascar	PH	Philippines	TF	French S.Territ		
BS	Bahamas	ES	Spain	IN	India	MH	Marshall Islnds	PK	Pakistan	TG	Togo		
BT	Bhutan	ET	Ethiopia	IO	Brit.Ind.Oc.Ter	MK	Macedonia	PL	Poland	TH	Thailand		
BV	Bouvet Island	FI	Finland	IQ	Iraq	ML	Mali	PM	St.Pier,Miquel.	TJ	Tajikstan		
BW	Botsw ana	FJ	Fiji	IR	Iran	MM	Myanmar	PN	Pitcairn Islnds	TK	Tokelau Islands		
BY	Belarus	FK	Falkland Islnds	IS	Iceland	MN	Mongolia	PR	Puerto Rico	TM	Turkmenistan		
BZ	Belize	FM	Micronesia	IT	Italy	MO	Macau	PT	Portugal	TN	Tunisia		

Message

Address

Post Box

RMDS

RETAIL MARKET DESIGN SERVICE

Country

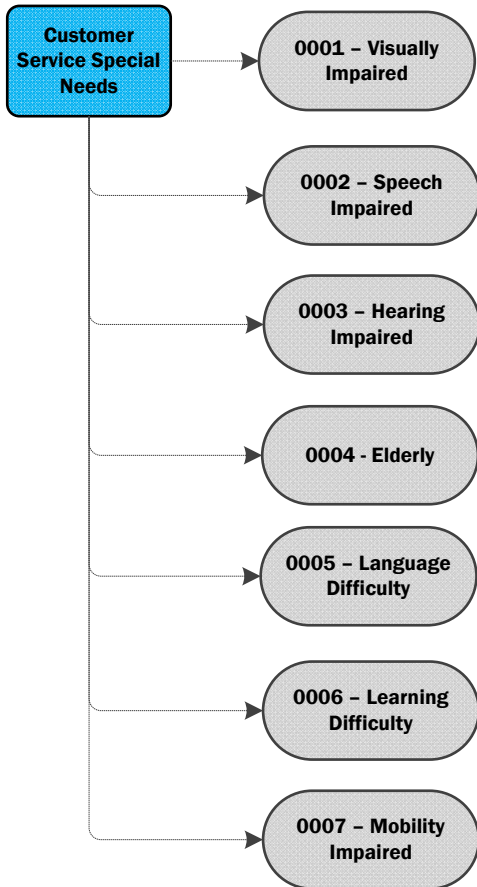

017 Meter Point Status Change Request

Version Which Implemented	Source of Change	Description of Change
10.4	MCR 1155	Message format changed from ARIS to Document format.