

342 Export Interval Meter Daily Readings

342 Valid Codes
Register Type
50 Import QH (Kw)
51 Import QH (kVAr)
52 Export QH (Kw)
53 Export QH (kVAr)
Unit of Measurements
KWT = kW
KVR = KVAr
Alert Flag (previously called Channel Status in v 6.1)
VV – all values are valid
VI – values are invalid. Typically this will be due to non-zero values on a de-energised site
Interval Status
VEST – indicates that the value is estimated
VCHG – indicates a value that has been manually changed by MRSO
VACH – indicates a value that has been manually changed (substituted) by PDS
VVAK – indicates that the value is collected or totalised from a meter
Optional/Mandatory; Although the following Data Items are optional, note the following caveats:-
Generator ID: Provided for export sites
Generation Unit ID: Provided for export sites
Value (Net Active Demand): Provided for import channels on export sites where netting occurs
. Unit of Measurements: KWT = kW
KVR = KVAr

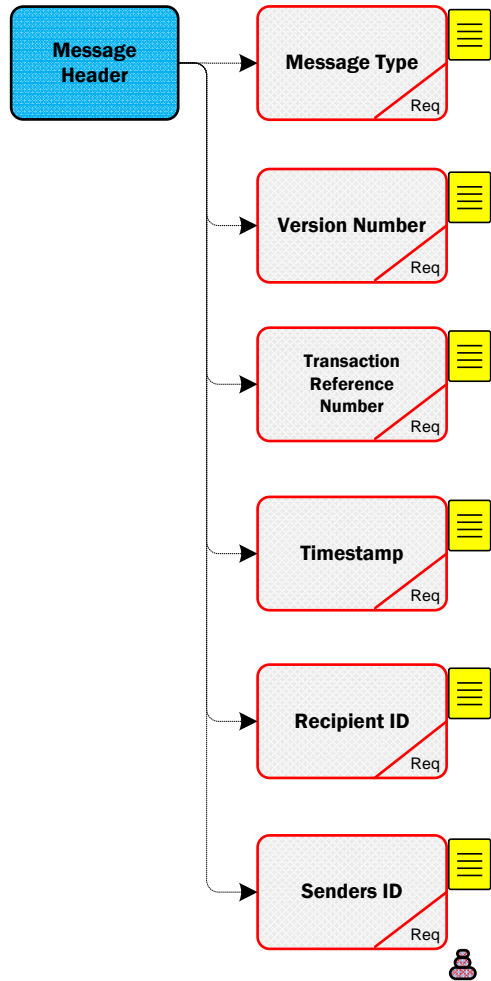

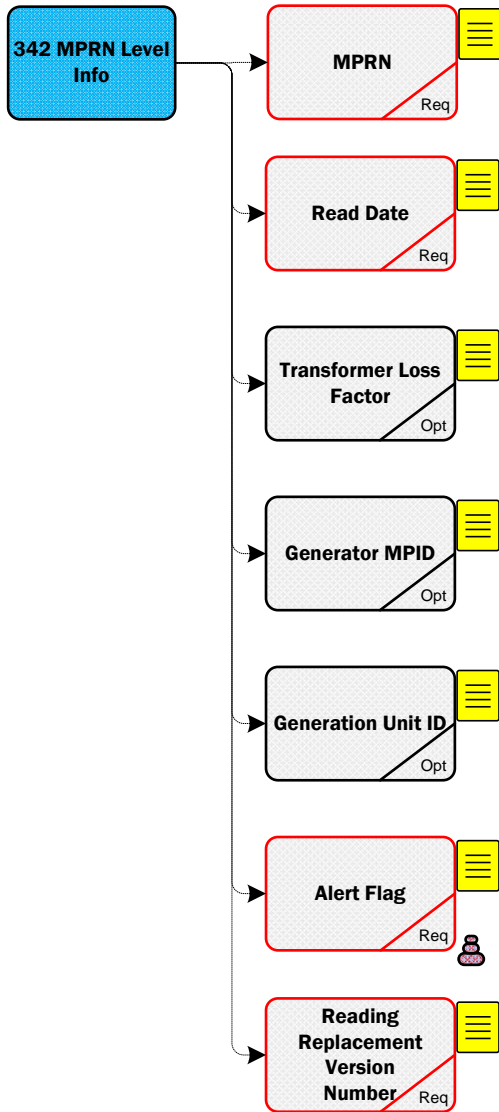

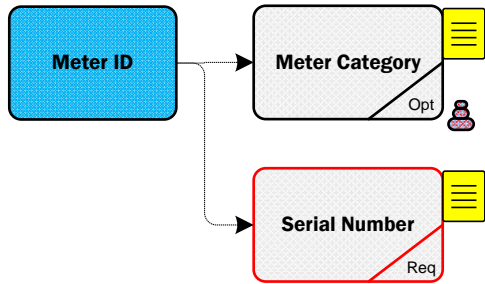

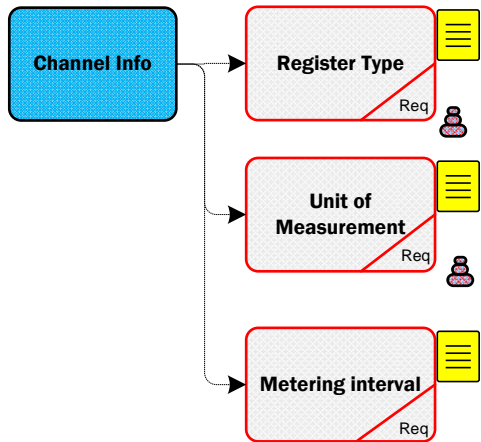

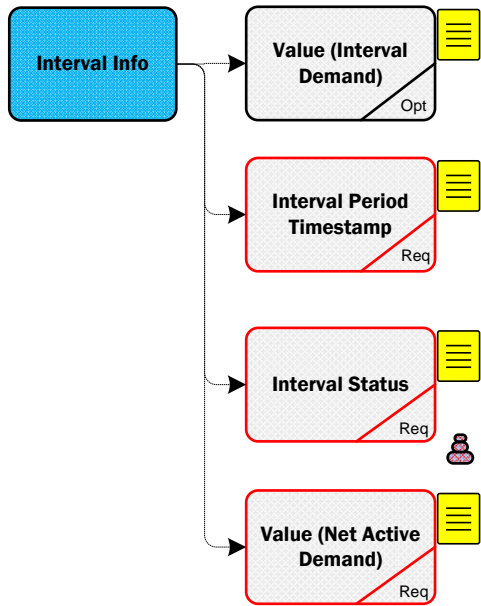

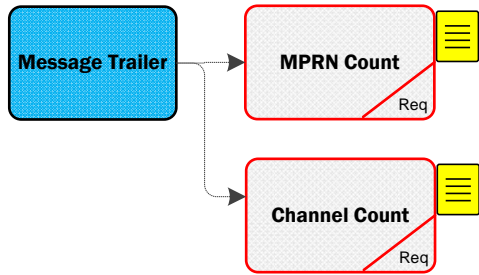

**Senders
ID**

**Click Here for Latest
Senders ID
List**

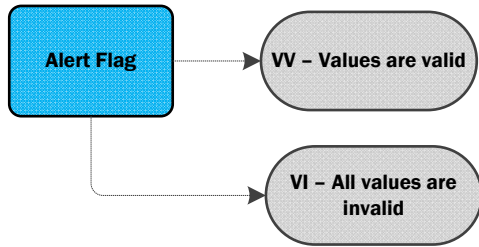

342 – Export Interval Meter Daily Readings

Code

Meter Category

RM001	Single Tariff kWh	RM228	Double Tariff kWh	RM511	Single Tariff kWh	RM621	C.T. Double Tariff kWh	RM752	M.F.M.
RM002	Single Tariff kWh	RM229	Double Tariff kWh	RM512	Single Tariff kWh	RM622	C.T. Double Tariff kWh	RM753	Double Tariff Mechanical MD
RM003	Single Tariff kWh	RM230	Double Tariff kWh	RM513	Single Tariff kWh	RM623	C.T. Double Tariff kWh	RM754	M.F.M.
RM004	Single Tariff kWh	RM231	Double Tariff kWh	RM514	Single Tariff kWh	RM624	C.T. Double Tariff kWh	RM755	M.F.M.
RM005	Single Tariff kWh	RM232	Double Tariff kWh 2 Element	RM515	Single Tariff kWh	RM625	C.T. Double Tariff kWh	RM756	M.F.M.
RM006	Single Tariff kWh	RM233	Double Tariff kWh 2 Element	RM516	3-Phase Mechanical Single Tariff Meter	RM626	C.T. Double Tariff kWh	RM757	M.F.M.
RM007	Single Tariff kWh	RM234	Double Tariff kWh	RM520	Double Tariff kWh	RM627	Electronic Double Tariff kWh	RM758	M.F.M.
RM008	Single Tariff kWh	RM235	Double Tariff kWh	RM521	Double Tariff kWh	RM640	C.T. Single Tariff Mech anical MD	RM759	M.F.M.
RM010	Single Tariff kWh	RM250	Electronic Double Tariff kWh	RM522	Double Tariff kWh	RM641	C.T. Single Tariff Mech anical MD	RM760	M.F.M.
RM011	Single Tariff kWh	RM251	Double Tariff kWh 2 Element	RM523	Double Tariff kWh	RM645	M.F.M.	RM761	M.F.M.
RM020	Single Tariff kWh	RM252	Electronic Double Tariff kWh	RM524	Double Tariff kWh	RM646	M.F.M.	RM762	M.F.M.
RM021	Single Tariff kWh	RM253	Electronic Double Tariff kWh (AMPY 5224E)	RM525	Double Tariff kWh	RM647	M.F.M.	RM763	M.F.M.
RM022	Single Tariff kWh	RM255	Electronic Multi rate kWh	RM526	Double Tariff kWh	RM648	M.F.M.	RM764	M.F.M.
RM030	Single Tariff kWh	RM256	Electronic Multi rate kWh	RM527	Double Tariff kWh	RM649	M.F.M.	RM765	M.F.M.
RM031	Single Tariff kWh	RM257	Electronic Multi Rate kWh	RM528	Double Tariff kWh	RM650	M.F.M.	RM766	M.F.M.
RM032	Single Tariff kWh	RM258	Electronic Multi Rate kWh	RM529	Double Tariff kWh	RM651	M.F.M.	RM767	M.F.M.
RM033	Single Tariff kWh	RM259	Electronic Multi Rate kWh	RM530	Double Tariff kWh	RM652	M.F.M.	RM768	M.F.M.
RM034	Single Tariff kWh	RM280	Hardw ired	RM531	Double Tariff kWh	RM660	C.T. Double Tariff Mechanical MD	RM769	M.F.M.
RM035	Single Tariff kWh	RM281	DLC	RM532	Double Tariff kWh	RM661	C.T. Double Tariff Mechanical MD	RM770	Single Tariff kVArh
RM036	Single Tariff kWh	RM300	Smart GPRS 3Ph WC 1-20(100)	RM533	Double Tariff kWh	RM662	C.T. Double Tariff Mechanical MD	RM771	Single Tariff kVArh
RM039	Single Tariff kWh	RM301	Smart DLC 3PH WC 0.25-5(80)A	RM534	RM534 - Electronic Double Tariff kWh	RM663	C.T. Double Tariff Mechanical MD	RM772	Single Tariff kVArh
RM040	Single Tariff kWh	RM302	Smart RF 3PH WC 0.5-10(100)A	RM540	Mechanical MD	RM664	C.T. Double Tariff Mechanical MD	RM773	Single Tariff kVArh
RM041	Single Tariff kWh	RM303	Smart RF 3PH WC 1-20(100)A	RM541	Mechanical MD	RM665	C.T. Double Tariff Mechanical MD	RM774	Single Tariff kVArh
RM042	Single Tariff kWh	RM304	Smart PLC 3PH WC 1-20(100)A	RM542	Mechanical MD	RM666	C.T. Double Tariff Mechanical MD	RM775	Single Tariff kVArh
RM043	Single Tariff kWh	RM350	Smart GPRS 3Ph WC 1-20(100)	RM543	Mechanical MD	RM667	M.F.M.	RM776	Single Tariff kVArh
RM050	Electronic Single Tariff kWh	RM351	Smart DLC 3PH CT 0.25-5(80)A	RM545	M.F.M.	RM670	C.T. kVArh	RM777	Single Tariff kVArh
RM051	Single Tariff kWh Budget Controller	RM352	Smart RF 3PH CT 0.5-10(100)A	RM546	M.F.M.	RM671	C.T. kVArh	RM780	Summator
RM052	Single Tariff kWh Budget Controller	RM353	Smart RF 3PH CT 1-20(100)A	RM547	M.F.M.	RM672	C.T. kVArh	RM781	M.F.M. (PWRM/PML Ion 7600)
RM054	Single Tariff kWh Budget Controller	RM354	Smart PLC 3PH CT 1-20(100)A	RM548	M.F.M.	RM673	C.T. kVArh	RM782	M.F.M. (PWRM/PML Ion 7650)
RM055	Single Tariff kWh Budget Controller	RM400	Single Tariff Current Transformer kWh	RM549	M.F.M.	RM674	C.T. kVArh	RM783	M.F.M. (PWRM/PML Ion 7650)
RM056	Single Tariff kWh Budget Controller	RM401	Single Tariff Current Transformer kWh	RM550	M.F.M. (Elster A1140)	RM675	C.T. kVArh	RM784	Summator (PSI Siemens Maxsys V2737/R33)
RM066	Electronic Single Tariff kWh	RM402	Single Tariff Current Transformer kWh	RM551	M.F.M.	RM676	C.T. kVArh	RM785	M.F.M
RM067	Electronic Single Tariff kWh	RM403	Single Tariff Current Transformer kWh	RM552	M.F.M.	RM720	Double Tariff kWh	RMAB1	Single Phase Single Tariff kWh
RM068	Electronic Single Tariff kWh	RM420	Double Tariff Current Transformer kWh	RM553	M.F.M.	RM721	Double Tariff kWh	RMAB3	Single Tariff kWh
RM100	Smart GPRS 1PH WC 1-20(100)A	RM421	Double Tariff Current Transformer kWh	RM570	Single Tariff kVArh	RM722	Double Tariff kWh	RMB10	Single Phase Single Tariff kWh
RM101	Smart DLC 1PH WC 0.25-5(80)A	RM422	Double Tariff Current Transformer kWh	RM571	Single Tariff kVArh	RM723	Double Tariff kWh	RMB14	Single Phase Single Tariff kWh
RM102	Smart RF 1PH WC 0.5-10(100)A	RM423	Double Tariff Current Transformer kWh	RM572	Single Tariff kVArh	RM740	Single Tariff Mechanical MD	RMB15	Single Tariff kWh
RM103	Smart RF 1PH WC 1-20(100)A	RM424	Double Tariff Current Transformer kWh	RM573	Single Tariff kVArh	RM741	Single Tariff Mechanical MD	RMB16	Single Phase Single Tariff kWh
RM104	Smart RF 1PH WC 1-20(100)A	RM425	Double Tariff Current Transformer kWh	RM574	Single Tariff kVArh	RM742	Single Tariff Mechanical MD	RMB20	Single Phase Single Tariff kWh
RM105	Smart PLC 1PH WC 1-20(100)A	RM426	Double Tariff Current Transformer kWh	RM575	Single Tariff kVArh	RM743	Double Tariff Mechanical MD	RMB34	Single Tariff kWh
RM220	Double Tariff kWh	RM500	Single Tariff kWh	RM576	Single Tariff kVArh	RM744	Double Tariff Mechanical MD	RMB36	Single Tariff kWh
RM221	Double Tariff kWh	RM501	Single Tariff kWh	RM600	C.T. Single Tariff kWh	RM745	Double Tariff Mechanical MD	RMB40	Single Phase Single Tariff kWh
RM222	Double Tariff kWh	RM502	Single Tariff kWh	RM601	C.T. Single Tariff kWh	RM746	Double Tariff Mechanical MD	RMB45	Single Phase Single Tariff kWh
RM223	Double Tariff kWh	RM503	Single Tariff kWh	RM602	C.T. Single Tariff kWh	RM747	Double Tariff Mechanical MD	RMB60	Single Phase Single Tariff kWh
RM224	Double Tariff kWh	RM504	Single Tariff kWh	RM603	C.T. Single Tariff kWh	RM748	Double Tariff Mechanical MD	RMB63	Single Tariff kWh
RM225	Double Tariff kWh	RM505	Single Tariff kWh	RM604	C.T. Single Tariff kWh	RM749	Double Tariff Mechanical MD	RMB80	Single Phase Single Tariff kWh
RM226	Double Tariff kWh	RM506	Single Tariff kWh	RM617	C.T. kVArh	RM750	Double Tariff Mechanical MD	RMDT1	Double Tariff kWh
RM227	Double Tariff kWh	RM510	Single Tariff kWh	RM620	C.T. Double Tariff kWh	RM751	Double Tariff Mechanical MD	RMDT3	Double Tariff kWh
								TKMTR	Single Phase Single Tariff kWh

Message

Meter ID

RMDS RETAIL MARKET DESIGN SERVICE

Meter Category

Register Type

- 01 - 24hr
- 01 - Day
- 03 - Night
- 04 - NSH
- 05 - Wattless
- 06 - MD Normal
- 07 - MD Peak
- 08 - Cumulative MD Normal
- 09 - Cumulative MD Peak
- 50 - IMP QH (KW)
- 51 - IMP QH (kVAr)
- 52 - EXP QH(KW)
- 53 - EXP QH (kVAr)

