

300S Validated Non Interval Readings Special

| |
|---|
| 300S Valid Codes |
| Meter Point Status |
| E - Energised |
| D - De-energised |
| Read Reason |
| 02 – Special Read that is chargeable |
| 09 – Special Read that is non-chargeable |
| Read Type |
| A An actual reading obtained by ESB Networks |
| E An estimate due to a missing register reading / no access |
| EF An estimate due to an implausible reading / No read available |
| Read Status |
| RV Reading which is plausible / valid |
| RREL Reading was originally implausible but released on investigation as plausible |
| REST Reading was estimated and usage factors deriving from estimate will be used in Settlement. See Read Type for reason for estimate. |
| RENS Reading was estimate but usage factors are not updated and will not be used in settlement. This is generally because a full set of readings was estimated due to implausibility. |
| |
| Optional/Mandatory; Although the following Data Items are optional, note the following caveats:- |
| Actual Usage Factor: Provided by the period terminating on the read date |
| Estimated Usage Factor: Provided for the period following the read date |

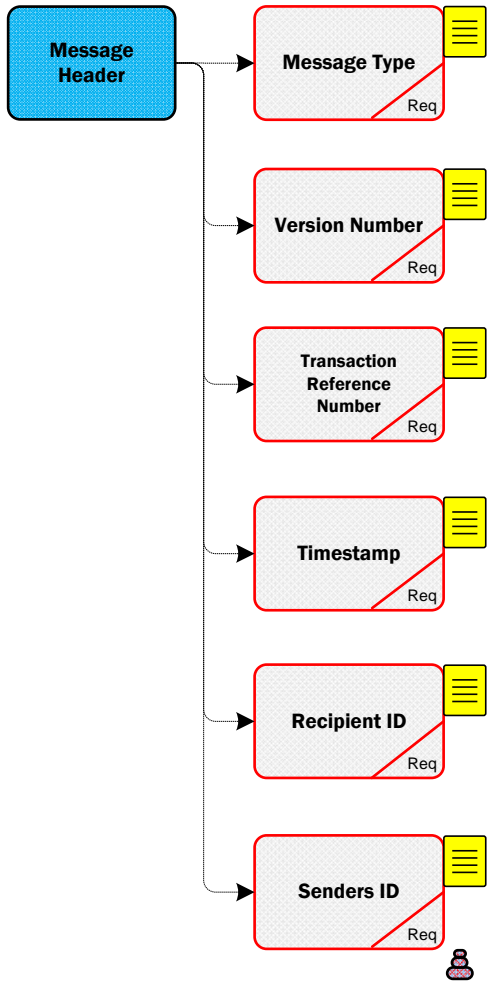

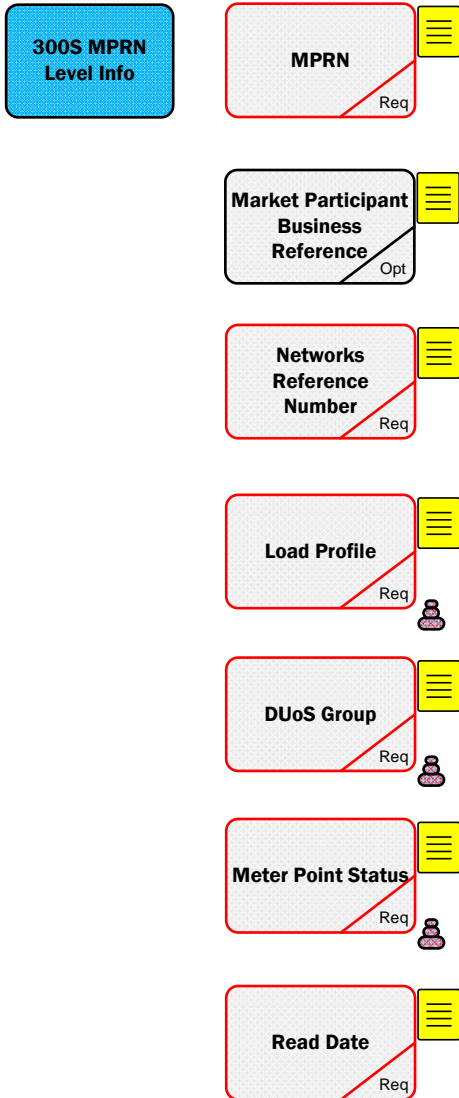

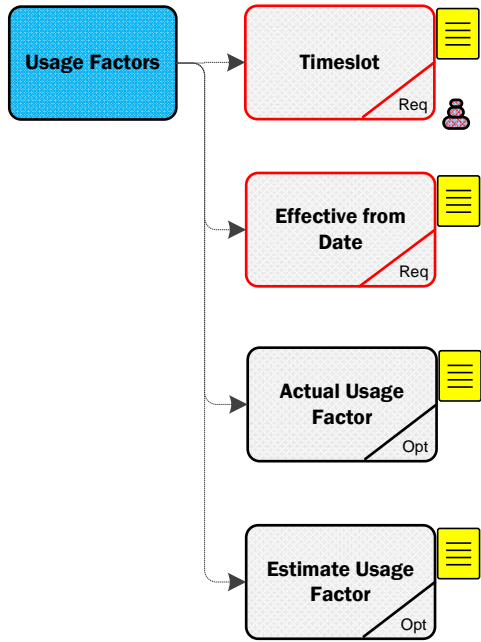

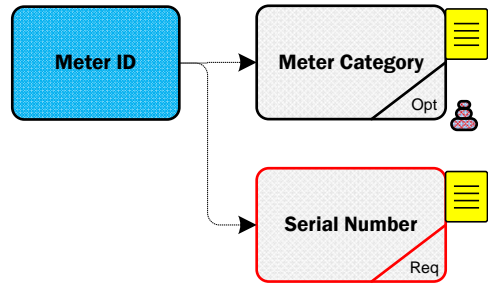

Register Level Information

Meter Registration Sequence
Req

Timeslot
Req

Unit of Measurement
Req

Meter Multiplier
Req

Reading
Req

Read Reason
Req

Read Type
Req

Register Type
Req

Previous Read Date
Req

Consumption
Opt

Read Status
Req

**Senders
ID**

**Click Here for Latest
Senders ID
List**

Load Profile

01 - Urban Domestic Unrestricted

10 - Unmetered - Flat

02 - Urban Domestic Day/Night

11 - Public Lighting Dusk/Dawn

03 - Rural Domestic Unrestricted

12 - Public Lighting Dusk/Midnight

04 - Rural Domestic Day/Night

05 - Non Domestic Unrestricted

06 - Non Domestic Day/Night

07 - MD with LF up to (but not including) 30%

08 - MD with LF greater than or equal to 30% but less than 50%

09 - MD with LF greater than or equal to 50%

300S Validated Non Interval Readings Special

Code

DUoS Group

| | | | | |
|-----|------|---|------|--|
| AGU | DG1 | Urban Domestic | DG7 | MV MD |
| AMM | DG10 | Yes | DG7A | MV MD Autoproducer |
| CAN | DG2 | Rural Domestic | DG7B | MV MD Importing Autoproducer or CHP Producer |
| CIP | DG3 | Public Lighting | DG8 | 38 kV Looped MD |
| COL | DG4 | Unmetered Supplies | DG8A | 38 kV Looped MD Autoproducer |
| COS | DG5 | LV Non-Domestic Non-MD | DG8B | 38 kV Looped MD Importing Autoproducer or CHP Producer |
| CUG | DG5A | LV Non-Domestic Non-MD Autoproducer | DG9 | 38 kV Tailed MD |
| DIJ | DG5B | LV Non-Domestic Non-MD Importing Autoproducer or CHP Producer | DG9A | 38 kV Tailed MD Autoproducer |
| DSO | DG6 | LV MD | DG9B | 38 kV Tailed MD Importing Autoproducer or CHP Producer |
| IA | DG6A | LV MD Autoproducer | DG10 | 110kV Distribution |
| ICD | DG6B | LV MD Importing Autoproducer or CHP Producer | TCON | Transmission Connected |

Message

MPRN Level Information

RMDS RETAIL MARKET DESIGN SERVICE

DUoS Group

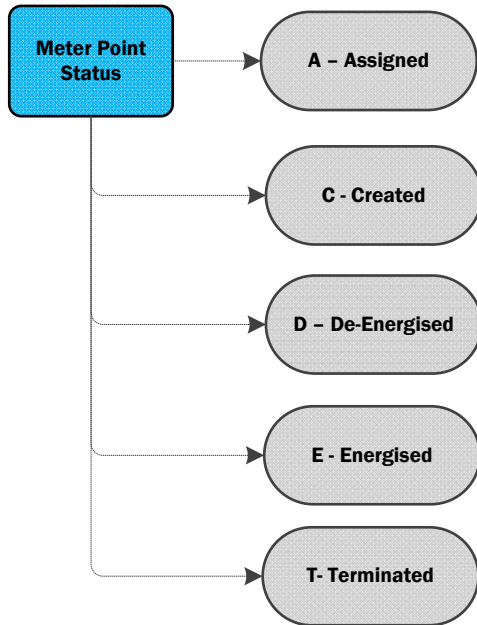

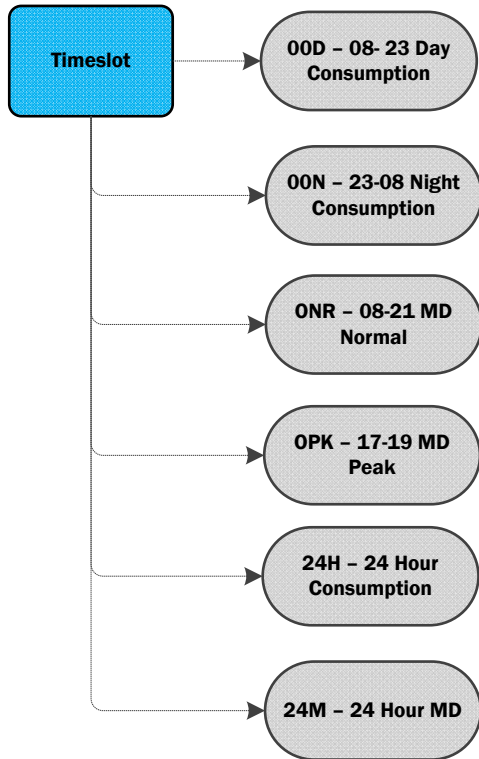

300S Validated Non Interval Readings Special

Code

Meter Category

| | | | | | | | | | |
|-------|-------------------------------------|-------|---|-------|--|-------|-----------------------------------|-------|---|
| RM001 | Single Tariff kWh | RM228 | Double Tariff kWh | RM511 | Single Tariff kWh | RM621 | C.T. Double Tariff kWh | RM752 | M.F.M. |
| RM002 | Single Tariff kWh | RM229 | Double Tariff kWh | RM512 | Single Tariff kWh | RM622 | C.T. Double Tariff kWh | RM753 | Double Tariff Mechanical MD |
| RM003 | Single Tariff kWh | RM230 | Double Tariff kWh | RM513 | Single Tariff kWh | RM623 | C.T. Double Tariff kWh | RM754 | M.F.M. |
| RM004 | Single Tariff kWh | RM231 | Double Tariff kWh | RM514 | Single Tariff kWh | RM624 | C.T. Double Tariff kWh | RM755 | M.F.M. |
| RM005 | Single Tariff kWh | RM232 | Double Tariff kWh 2 Element | RM515 | Single Tariff kWh | RM625 | C.T. Double Tariff kWh | RM756 | M.F.M. |
| RM006 | Single Tariff kWh | RM233 | Double Tariff kWh 2 Element | RM516 | 3-Phase Mechanical Single Tariff Meter | RM626 | C.T. Double Tariff kWh | RM757 | M.F.M. |
| RM007 | Single Tariff kWh | RM234 | Double Tariff kWh | RM520 | Double Tariff kWh | RM627 | Electronic Double Tariff kWh | RM758 | M.F.M. |
| RM008 | Single Tariff kWh | RM235 | Double Tariff kWh | RM521 | Double Tariff kWh | RM640 | C.T. Single Tariff Mech anical MD | RM759 | M.F.M. |
| RM010 | Single Tariff kWh | RM250 | Electronic Double Tariff kWh | RM522 | Double Tariff kWh | RM641 | C.T. Single Tariff Mech anical MD | RM760 | M.F.M. |
| RM011 | Single Tariff kWh | RM251 | Double Tariff kWh 2 Element | RM523 | Double Tariff kWh | RM645 | M.F.M. | RM761 | M.F.M. |
| RM020 | Single Tariff kWh | RM252 | Electronic Double Tariff kWh | RM524 | Double Tariff kWh | RM646 | M.F.M. | RM762 | M.F.M. |
| RM021 | Single Tariff kWh | RM253 | Electronic Double Tariff kWh (AMPY 5224E) | RM525 | Double Tariff kWh | RM647 | M.F.M. | RM763 | M.F.M. |
| RM022 | Single Tariff kWh | RM255 | Electronic Multi rate kWh | RM526 | Double Tariff kWh | RM648 | M.F.M. | RM764 | M.F.M. |
| RM030 | Single Tariff kWh | RM256 | Electronic Multi rate kWh | RM527 | Double Tariff kWh | RM649 | M.F.M. | RM765 | M.F.M. |
| RM031 | Single Tariff kWh | RM257 | Electronic Multi Rate kWh | RM528 | Double Tariff kWh | RM650 | M.F.M. | RM766 | M.F.M. |
| RM032 | Single Tariff kWh | RM258 | Electronic Multi Rate kWh | RM529 | Double Tariff kWh | RM651 | M.F.M. | RM767 | M.F.M. |
| RM033 | Single Tariff kWh | RM259 | Electronic Multi Rate kWh | RM530 | Double Tariff kWh | RM652 | M.F.M. | RM768 | M.F.M. |
| RM034 | Single Tariff kWh | RM280 | Hardw ired | RM531 | Double Tariff kWh | RM660 | C.T. Double Tariff Mechanical MD | RM769 | M.F.M. |
| RM035 | Single Tariff kWh | RM281 | DLC | RM532 | Double Tariff kWh | RM661 | C.T. Double Tariff Mechanical MD | RM770 | Single Tariff kVArh |
| RM036 | Single Tariff kWh | RM300 | Smart GPRS 3Ph WC 1-20(100) | RM533 | Double Tariff kWh | RM662 | C.T. Double Tariff Mechanical MD | RM771 | Single Tariff kVArh |
| RM039 | Single Tariff kWh | RM301 | Smart DLC 3PH WC 0.25-5(80)A | RM534 | RM534 - Electronic Double Tariff kWh | RM663 | C.T. Double Tariff Mechanical MD | RM772 | Single Tariff kVArh |
| RM040 | Single Tariff kWh | RM302 | Smart RF 3PH WC 0.5-10(100)A | RM540 | Mechanical MD | RM664 | C.T. Double Tariff Mechanical MD | RM773 | Single Tariff kVArh |
| RM041 | Single Tariff kWh | RM303 | Smart RF 3PH WC 1-20(100)A | RM541 | Mechanical MD | RM665 | C.T. Double Tariff Mechanical MD | RM774 | Single Tariff kVArh |
| RM042 | Single Tariff kWh | RM304 | Smart PLC 3PH WC 1-20(100)A | RM542 | Mechanical MD | RM666 | C.T. Double Tariff Mechanical MD | RM775 | Single Tariff kVArh |
| RM043 | Single Tariff kWh | RM350 | Smart GPRS 3Ph WC 1-20(100) | RM543 | Mechanical MD | RM667 | M.F.M. | RM776 | Single Tariff kVArh |
| RM050 | Electronic Single Tariff kWh | RM351 | Smart DLC 3PH CT 0.25-5(80)A | RM545 | M.F.M. | RM670 | C.T. kVArh | RM777 | Single Tariff kVArh |
| RM051 | Single Tariff kWh Budget Controller | RM352 | Smart RF 3PH CT 0.5-10(100)A | RM546 | M.F.M. | RM671 | C.T. kVArh | RM780 | Summator |
| RM052 | Single Tariff kWh Budget Controller | RM353 | Smart RF 3PH CT 1-20(100)A | RM547 | M.F.M. | RM672 | C.T. kVArh | RM781 | M.F.M. (PWRM/PML Ion 7600) |
| RM054 | Single Tariff kWh Budget Controller | RM354 | Smart PLC 3PH CT 1-20(100)A | RM548 | M.F.M. | RM673 | C.T. kVArh | RM782 | M.F.M. (PWRM/PML Ion 7650) |
| RM055 | Single Tariff kWh Budget Controller | RM400 | Single Tariff Current Transformer kWh | RM549 | M.F.M. | RM674 | C.T. kVArh | RM783 | M.F.M. (PWRM/PML Ion 7650) |
| RM056 | Single Tariff kWh Budget Controller | RM401 | Single Tariff Current Transformer kWh | RM550 | M.F.M. (Elster A1140) | RM675 | C.T. kVArh | RM784 | Summator (PSI Siemens Maxsys V2737/R33) |
| RM066 | Electronic Single Tariff kWh | RM402 | Single Tariff Current Transformer kWh | RM551 | M.F.M. | RM676 | C.T. kVArh | RM785 | M.F.M |
| RM067 | Electronic Single Tariff kWh | RM403 | Single Tariff Current Transformer kWh | RM552 | M.F.M. | RM720 | Double Tariff kWh | RMAB1 | Single Phase Single Tariff kWh |
| RM068 | Electronic Single Tariff kWh | RM420 | Double Tariff Current Transformer kWh | RM553 | M.F.M. | RM721 | Double Tariff kWh | RMAB3 | Single Tariff kWh |
| RM100 | Smart GPRS 1PH WC 1-20(100)A | RM421 | Double Tariff Current Transformer kWh | RM570 | Single Tariff kVArh | RM722 | Double Tariff kWh | RMB10 | Single Phase Single Tariff kWh |
| RM101 | Smart DLC 1PH WC 0.25-5(80)A | RM422 | Double Tariff Current Transformer kWh | RM571 | Single Tariff kVArh | RM723 | Double Tariff kWh | RMB14 | Single Phase Single Tariff kWh |
| RM102 | Smart RF 1PH WC 0.5-10(100)A | RM423 | Double Tariff Current Transformer kWh | RM572 | Single Tariff kVArh | RM740 | Single Tariff Mechanical MD | RMB15 | Single Tariff kWh |
| RM103 | Smart RF 1PH WC 1-20(100)A | RM424 | Double Tariff Current Transformer kWh | RM573 | Single Tariff kVArh | RM741 | Single Tariff Mechanical MD | RMB16 | Single Phase Single Tariff kWh |
| RM104 | Smart RF 1PH WC 1-20(100)A | RM425 | Double Tariff Current Transformer kWh | RM574 | Single Tariff kVArh | RM742 | Single Tariff Mechanical MD | RMB20 | Single Phase Single Tariff kWh |
| RM105 | Smart PLC 1PH WC 1-20(100)A | RM426 | Double Tariff Current Transformer kWh | RM575 | Single Tariff kVArh | RM743 | Double Tariff Mechanical MD | RMB34 | Single Tariff kWh |
| RM220 | Double Tariff kWh | RM500 | Single Tariff kWh | RM576 | Single Tariff kVArh | RM744 | Double Tariff Mechanical MD | RMB36 | Single Tariff kWh |
| RM221 | Double Tariff kWh | RM501 | Single Tariff kWh | RM600 | C.T. Single Tariff kWh | RM745 | Double Tariff Mechanical MD | RMB40 | Single Phase Single Tariff kWh |
| RM222 | Double Tariff kWh | RM502 | Single Tariff kWh | RM601 | C.T. Single Tariff kWh | RM746 | Double Tariff Mechanical MD | RMB45 | Single Phase Single Tariff kWh |
| RM223 | Double Tariff kWh | RM503 | Single Tariff kWh | RM602 | C.T. Single Tariff kWh | RM747 | Double Tariff Mechanical MD | RMB60 | Single Phase Single Tariff kWh |
| RM224 | Double Tariff kWh | RM504 | Single Tariff kWh | RM603 | C.T. Single Tariff kWh | RM748 | Double Tariff Mechanical MD | RMB63 | Single Tariff kWh |
| RM225 | Double Tariff kWh | RM505 | Single Tariff kWh | RM604 | C.T. Single Tariff kWh | RM749 | Double Tariff Mechanical MD | RMB80 | Single Phase Single Tariff kWh |
| RM226 | Double Tariff kWh | RM506 | Single Tariff kWh | RM617 | C.T. kVArh | RM750 | Double Tariff Mechanical MD | RMDT1 | Double Tariff kWh |
| RM227 | Double Tariff kWh | RM510 | Single Tariff kWh | RM620 | C.T. Double Tariff kWh | RM751 | Double Tariff Mechanical MD | RMDT3 | Double Tariff kWh |
| | | | | | | | | TKMTR | Single Phase Single Tariff kWh |

Message

Meter ID

RMDS RETAIL MARKET DESIGN SERVICE

Meter Category

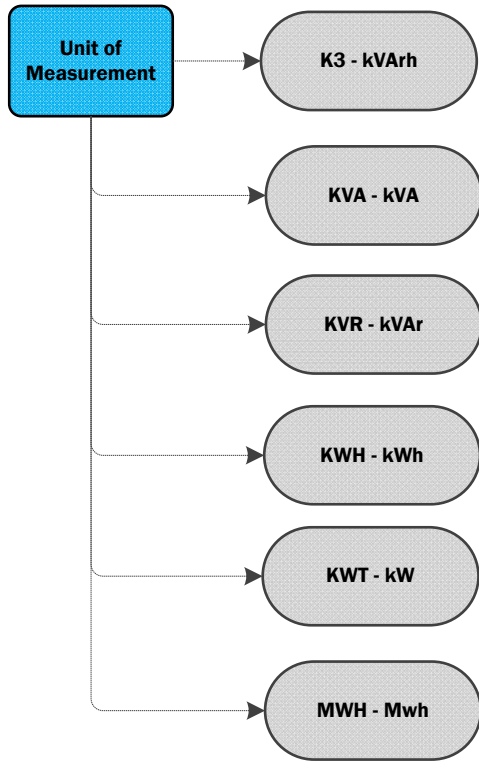

Read Reason

01 - Scheduled

17 - Change of Profile

95 - Not for CoS

02 - Special Read, Chargeable

18 - Energisation

04 - Special Read to resolve dispute

21 - Start Reading (New Register)

09 - Special Read, non chargeable

22 - Closing Reading (Register removed)

10 - Ad-hoc, no chargeable check read

23 - Meter Works Single reading

11 - Start reading after meter re-programming

26 - Change of Supplier

13 - De-Energisation

27 - Change of Legal Entity

14 - Estimate

28 - Closing read before register re-number

16 - Closing read before meter re-programming

29 - Star read after register re-number

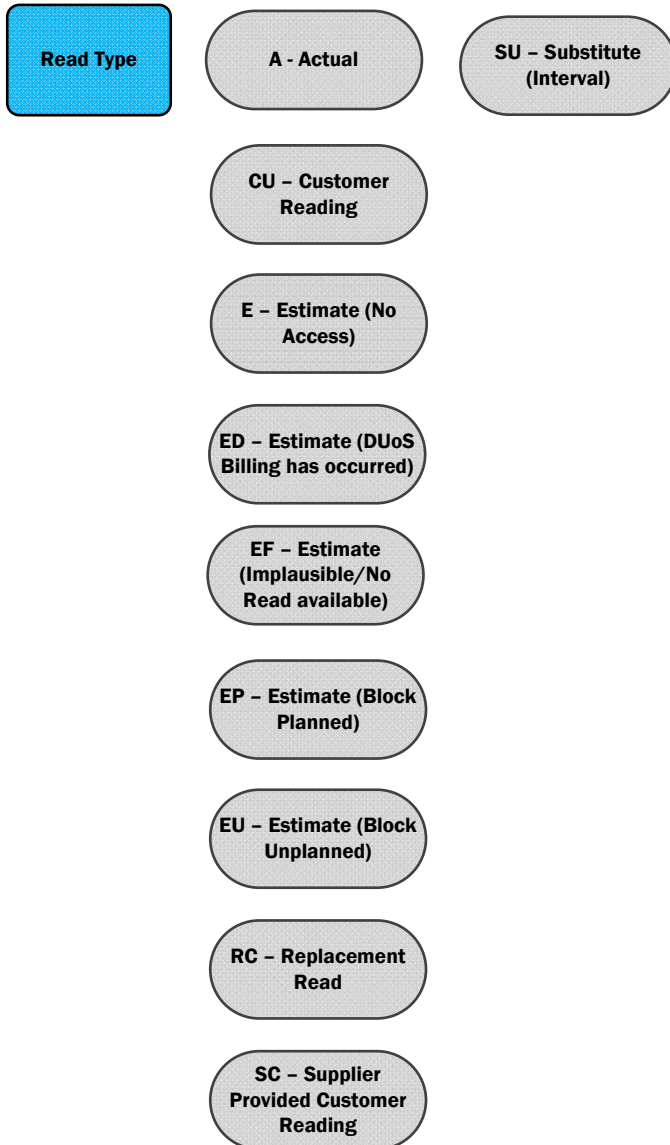

Register Type

01 - 24hr

50 - IMP QH (KW)

01 - Day

51 - IMP QH (kVAr)

03 - Night

52 - EXP QH(KW)

04 - NSH

53 - EXP QH (kVAr)

05 - Wattless

06 - MD Normal

07 - MD Peak

08 - Cumulative MD
Normal

09 - Cumulative MD
Peak

Message

Register Level Info

