

## 331 Interval Meter Technical Details

<b>331 Valid Codes</b>
<b>Meter Point Status</b>
E or D only.
<b>MCC</b>
MCC10
MCC11
<b>Register Type</b>
50 Import QH (Kw)
51 Import QH (kVAr)
52 Export QH (Kw)
53 Export QH (kVAr)
<b>Unit of Measurements</b>
KWT = kW
KVR = KVAR
<b>Optional/Mandatory;</b> Although the following Data Items are optional, note the following caveats:-
Exchanged Meter Reference: To be provided where a meter exchange has occurred

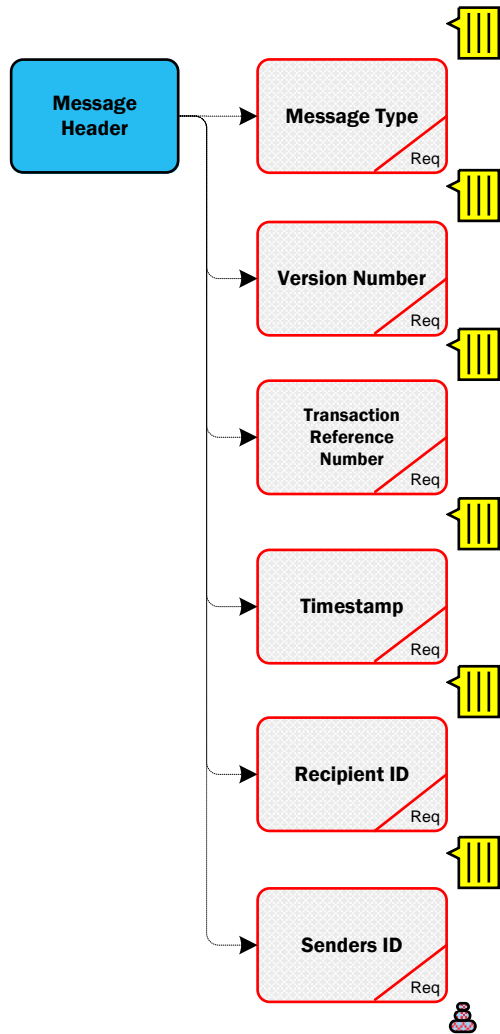

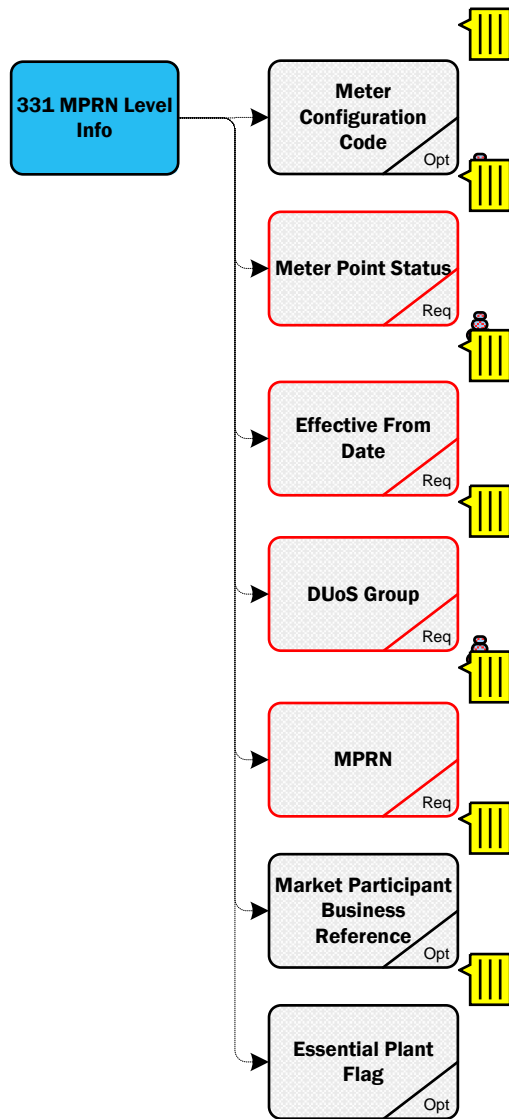

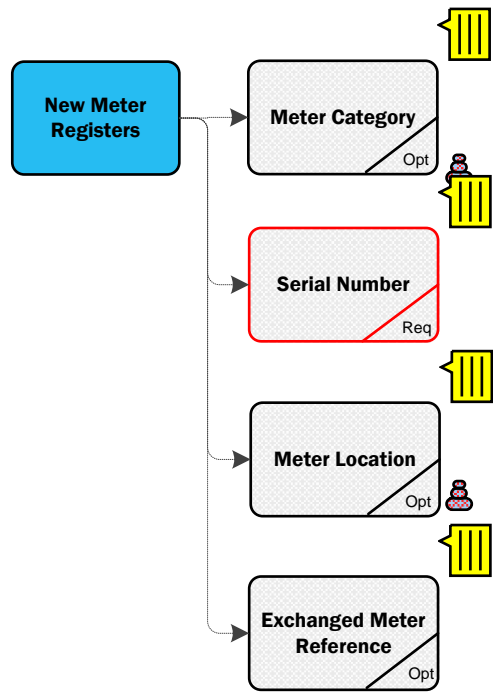

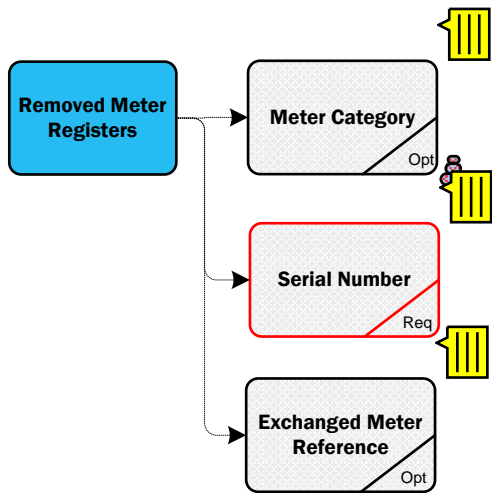

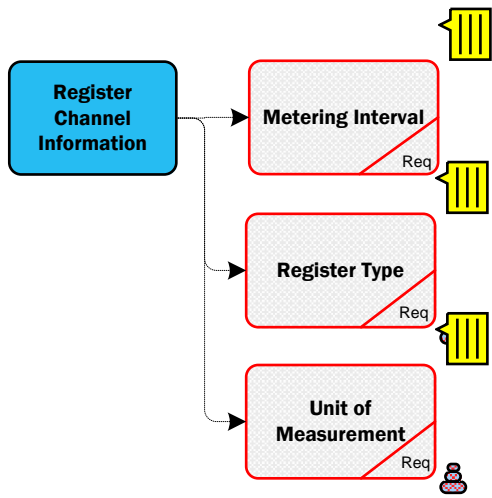

**Senders  
ID**

**Click Here for Latest  
Senders ID  
List**



Meter Configuration Code				
MCC01 - 24 Hour	MCC10 - QH2CH_IP	MCC61 - 2x24h	MCC73 - 4x24H+NSH	
MCC02 - P/N	MCC11 - QH4CH_IPXP	MCC62 - 2x24h+NSH	MCC74 - 5x24H	
MCC03 - 24h+NSH	MCC50 - NONSTN	MCC63 - 2x24h+D	MCC75 - 24H+2xNSH	
MCC04 - D/N+W	MCC51 - D/N+NSH	MCC64 - 2x24h+W	MCC76 - 4x24H+W	
MCC05 - MDNm/PK	MCC53 - 2 X D/N	MCC65 - 3x24hr	MCC77 - 2x24H+W+NSH	
MCC06 - MDNm+Pk	MCC57 - 24h+D	MCC67 - 3x24h+Day	MCC78 - 3x24H+W+NSH	
MCC07 - 24H+NSH+W	MCC58 - 24h+D/N	MCC70 - 3x24H+NSH	MCC79 - 5x24H+NSH	
MCC08 - 24h+W	MCC59 - 24h+D/N+W	MCC71 - 4x24H		
MCC09 - Unmetered	MCC60 - 24h+D/N+NS	MCC72 - 3x24H+W		

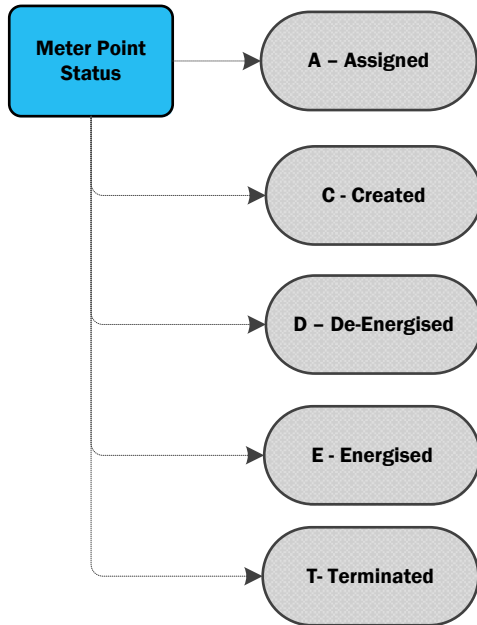

# 331 Interval Meter Technical Details

Code

DUoS Group

AGU	DG1	Urban Domestic	DG7	MV MD
AMM	DG10	Yes	DG7A	MV MD Autoproducer
CAN	DG2	Rural Domestic	DG7B	MV MD Importing Autoproducer or CHP Producer
CIP	DG3	Public Lighting	DG8	38 kV Looped MD
COL	DG4	Unmetered Supplies	DG8A	38 kV Looped MD Autoproducer
COS	DG5	LV Non-Domestic Non-MD	DG8B	38 kV Looped MD Importing Autoproducer or CHP Producer
CUG	DG5A	LV Non-Domestic Non-MD Autoproducer	DG9	38 kV Tailed MD
DIJ	DG5B	LV Non-Domestic Non-MD Importing Autoproducer or CHP Producer	DG9A	38 kV Tailed MD Autoproducer
DSO	DG6	LV MD	DG9B	38 kV Tailed MD Importing Autoproducer or CHP Producer
IA	DG6A	LV MD Autoproducer	DG10	110kV Distribution
ICD	DG6B	LV MD Importing Autoproducer or CHP Producer	TCON	Transmission Connected

Message

MPRN Level Information

**RMDS** RETAIL MARKET DESIGN SERVICE

DUoS Group

**Meter Category**

**Click Here for Latest  
Meter Category  
List**

### Meter Location

01 - Basement	10 - Pumphouse	19 - Annexe
02 - Garage	11 - Scullery/ Pantry/Kitchen	20 - Milking parlour/ Dairy
03 - Hall	12 - Shop	21 - Workshop
04 - Kitchen	13 - Switchroom/ Board	22 - Store
05 - Landing	14 - Under Stairs	23 - Back door
06 - Office	15 - Car Park	24 - Bedroom
07 - Outside box	16 - Pole	25 - Boiler House
08 - Porch	17 - Lobby	26 - Factory
09 - Press	18 - Shed/Outoffice/ Barn	

### Register Type

01 - 24hr

50 - IMP QH (KW)

02 - Day

51 - IMP QH (kVAr)

03 - Night

52 - EXP QH(KW)

04 - NSH

53 - EXP QH (kVAr)

05 - Wattless

06 - MD Normal

07 - MD Peak

08 - Cumulative MD Normal

09 - Cumulative MD Peak

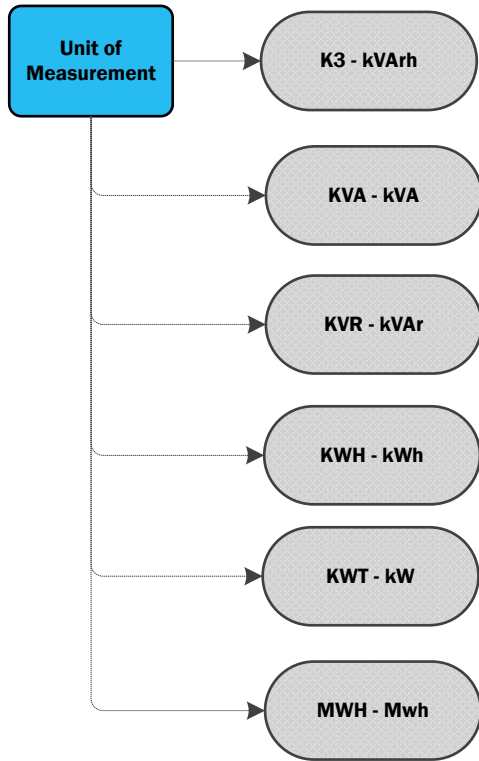

Version Which Implemented	Source of Change	Description of Change
10.4	MCR 1155	Message format changed from ARIS to Document format.
10.6	CoBLCR 008 & CoBLCR 011	Meter Category - Removed table & replaced with link to Meter Category page on RMDS Website
11.0	MCR 1122	New Data Item Essential Plant Flag added