

306 Meter Point Status Change Confirmation DeEnergisation

306 Valid Codes

Meter Point Status

This will always be set to D – De-energised on this message.

Read Reason

13 - De-energise only

Read Type

A Actual

E Estimated (No Access)

EF Estimate (Implausible / No read available)

Read Status

RV Reading which is plausible / valid

RREL Reading was originally implausible but released on investigation as plausible

REST Reading was estimated and usage factors deriving from estimate will be used in Settlement. See Read Type for reason for estimate.

RENS Reading was estimate but usage factors are not updated and will not be used in settlement. This is generally because a full set of readings was estimated due to implausibility.

Register Type

01 24Hr

02 Day

03 Night

04 NSH

05 Wattless

06 MD Normal

07 MD Peak

08 Cumulative MD Normal

09 Cumulative MD Peak

Optional/Mandatory; Although the following Data Items are optional, note the following caveats:-

Actual Usage Factor: Provided by the period terminating on the read date

Estimated Usage Factor: Provided for the period following the read date

Message

RMDS RETAIL MARKET DESIGN SERVICE

Message Specific information

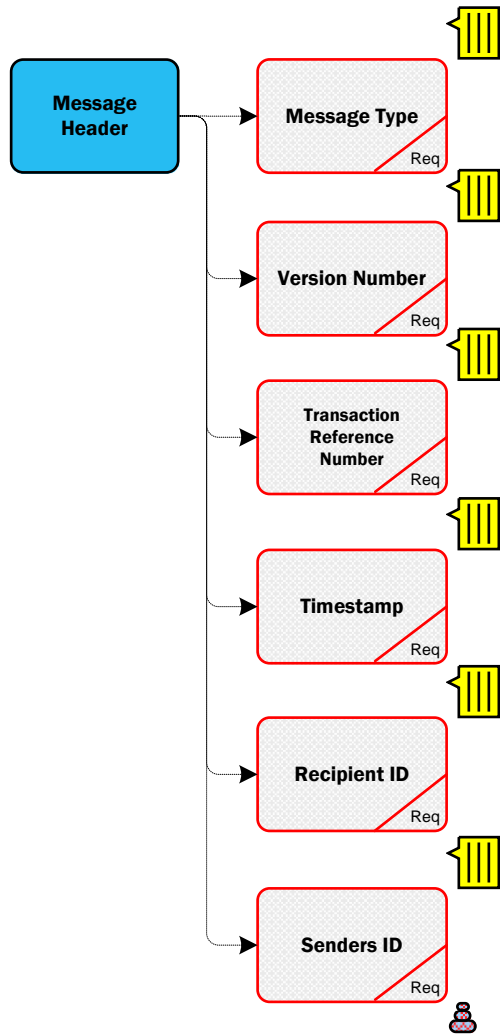

306 MPRN Level Info

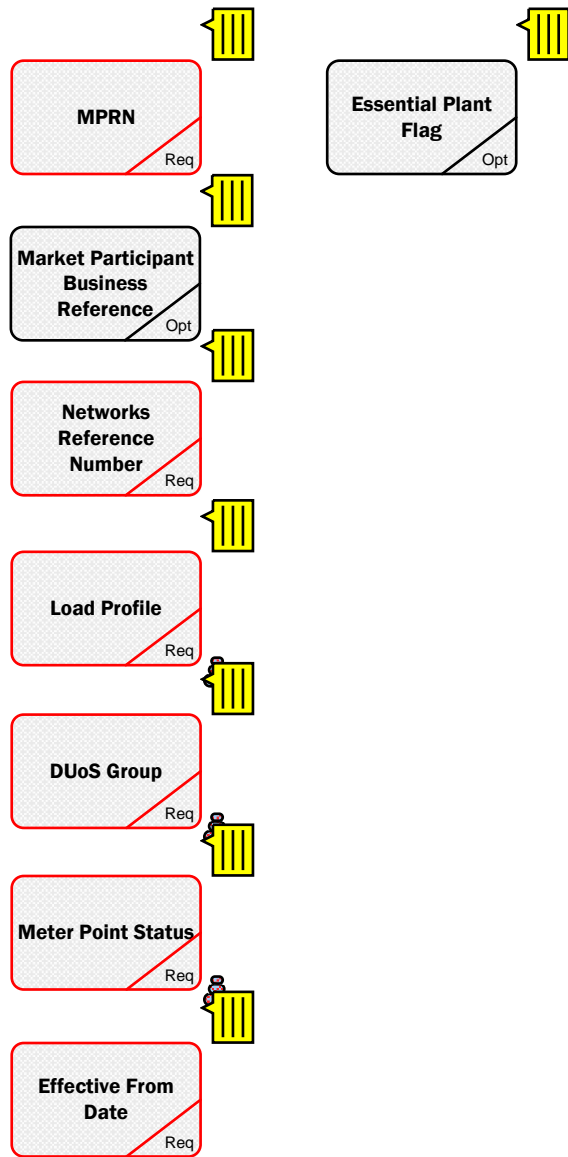

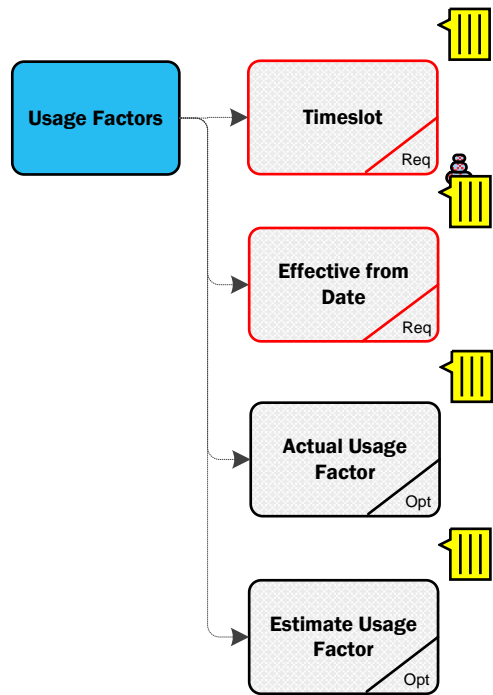

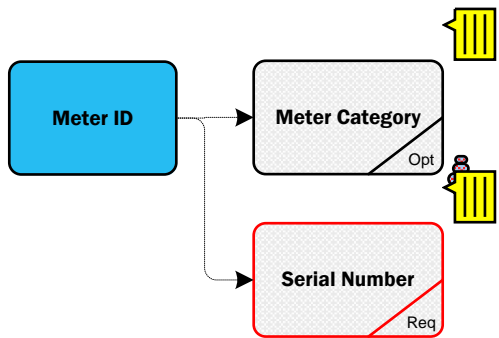

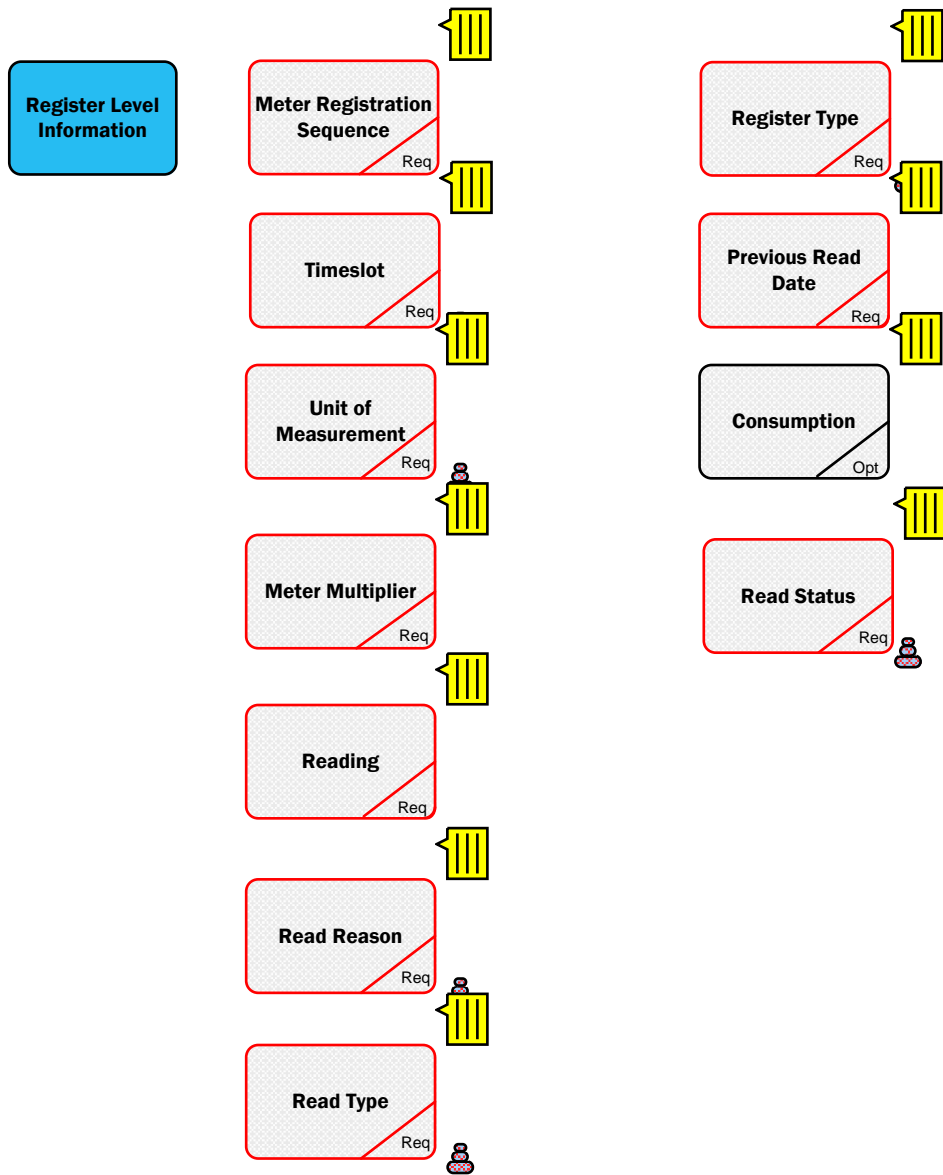

**Senders
ID**

**Click Here for Latest
Senders ID
List**

Load Profile

01 - Urban Domestic Unrestricted

10 - Unmetered - Flat

02 - Urban Domestic Day/Night

11 - Public Lighting Dusk/Dawn

03 - Rural Domestic Unrestricted

12 - Public Lighting Dusk/Midnight

04 - Rural Domestic Day/Night

05 - Non Domestic Unrestricted

06 - Non Domestic Day/Night

07 - MD with LF up to (but not including) 30%

08 - MD with LF greater than or equal to 30% but less than 50%

09 - MD with LF greater than or equal to 50%

306 Meter Point Status Change Confirmation DeEnergisation

Code

DUoS Group

| | | | | |
|-----|------|---|------|--|
| AGU | DG1 | Urban Domestic | DG7 | MV MD |
| AMM | DG10 | Yes | DG7A | MV MD Autoproducer |
| CAN | DG2 | Rural Domestic | DG7B | MV MD Importing Autoproducer or CHP Producer |
| CIP | DG3 | Public Lighting | DG8 | 38 kV Looped MD |
| COL | DG4 | Unmetered Supplies | DG8A | 38 kV Looped MD Autoproducer |
| COS | DG5 | LV Non-Domestic Non-MD | DG8B | 38 kV Looped MD Importing Autoproducer or CHP Producer |
| CUG | DG5A | LV Non-Domestic Non-MD Autoproducer | DG9 | 38 kV Tailed MD |
| DIJ | DG5B | LV Non-Domestic Non-MD Importing Autoproducer or CHP Producer | DG9A | 38 kV Tailed MD Autoproducer |
| DSO | DG6 | LV MD | DG9B | 38 kV Tailed MD Importing Autoproducer or CHP Producer |
| IA | DG6A | LV MD Autoproducer | DG10 | 110kV Distribution |
| ICD | DG6B | LV MD Importing Autoproducer or CHP Producer | TCON | Transmission Connected |

Message

MPRN Level Information

RMDS RETAIL MARKET DESIGN SERVICE

DUoS Group

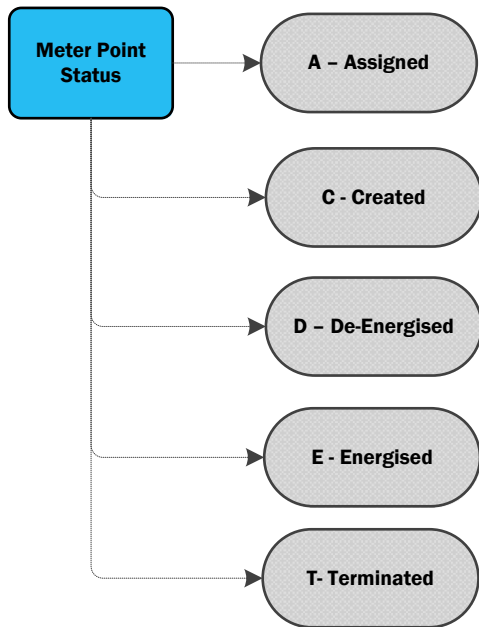

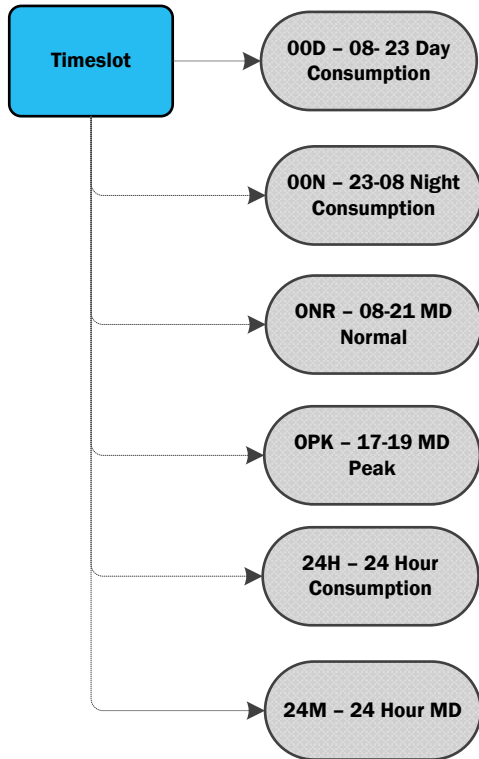

Meter Category

**Click Here for Latest
Meter Category
List**

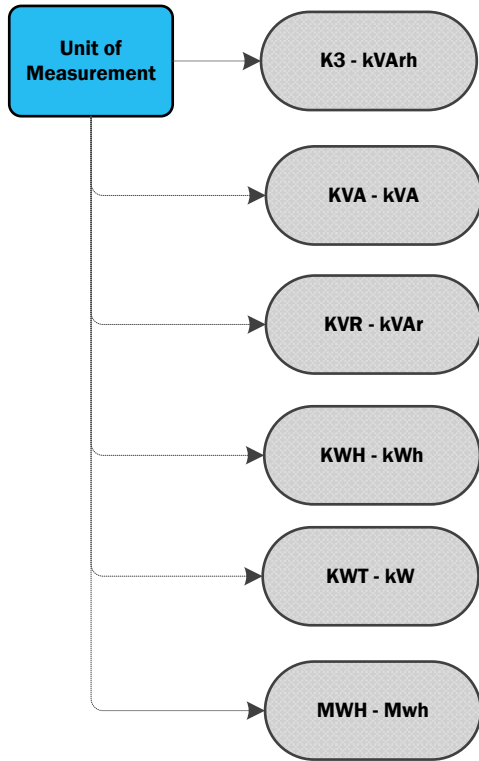

Read Reason

01 - Scheduled

17 - Change of Profile

95 - Not for CoS

02 - Special Read, Chargeable

18 - Energisation

04 - Special Read to resolve dispute

21 - Start Reading (New Register)

09 - Special Read, non chargeable

22 - Closing Reading (Register removed)

10 - Ad-hoc, no chargeable check read

23 - Meter Works Single reading

11 - Start reading after meter re-programming

26 - Change of Supplier

13 - De-Energisation

27 - Change of Legal Entity

14 - Estimate

28 - Closing read before register re-number

16 - Closing read before meter re-programming

29 - Star read after register re-number

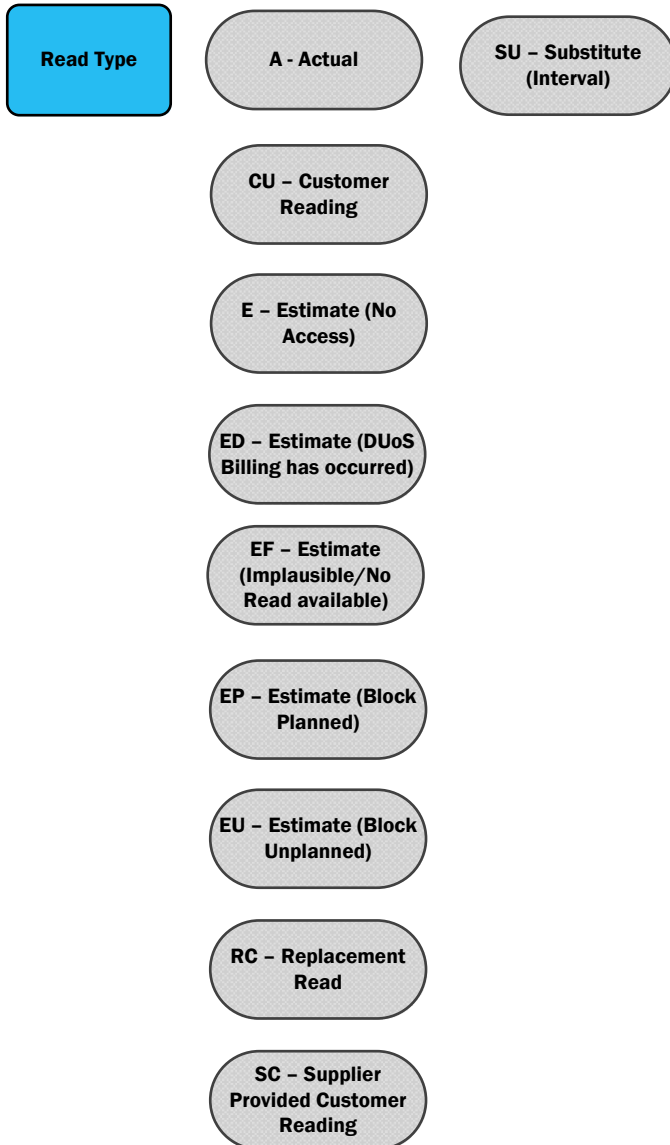

Register Type

01 - 24hr

50 - IMP QH (KW)

02 - Day

51 - IMP QH (kVAr)

03 - Night

52 - EXP QH(KW)

04 - NSH

53 - EXP QH (kVAr)

05 - Wattless

06 - MD Normal

07 - MD Peak

08 - Cumulative MD Normal

09 - Cumulative MD Peak

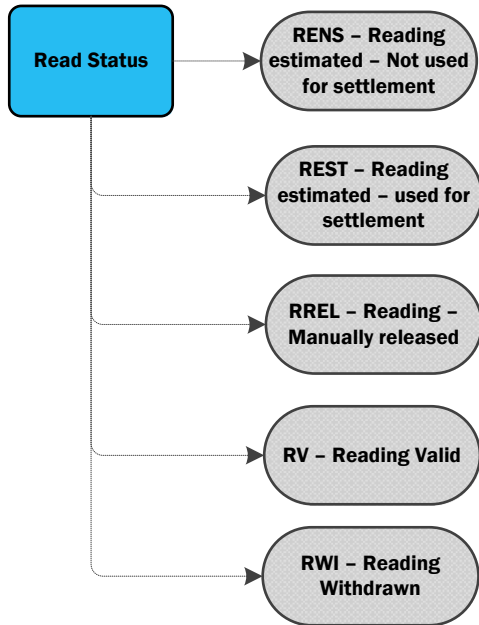

306 Meter Point Status Change Confirmation DeEnergisation

| Version Which Implemented | Source of Change | Description of Change |
|---------------------------|-------------------------|--|
| 10.4 | MCR 1155 | Message format changed from ARIS to Document format. |
| 10.6 | CoBLCR 008 & CoBLCR 011 | Meter Category - Removed table & replaced with link to Meter Category page on RMDS Website |
| 11.0 | MCR 1122 | New Data Item Essential Plant Flag added |