

## 300 Validated Non Interval Readings Scheduled

<b>Meter Point Status</b>
<b>E</b> - Energised
<b>D</b> - De-energised
<b>Read Reason</b>
<b>01</b> Scheduled Read
<b>10</b> Ad hoc, non chargeable check read
<b>27</b> Change of Legal Entity
<b>Read Type</b>
<b>A</b> An actual reading obtained by ESB Networks
<b>CU</b> A reading provided directly by a customer
<b>E</b> An estimate due to a missing register reading / no access
<b>ED</b> An estimate due to a CoLE reading preceding the last DUoS billing date
<b>EF</b> An estimate due to an implausible reading / No read available
<b>SC</b> A customer reading provided by a Supplier
<b>Read Status</b>
<b>RV</b> Reading which is plausible / valid
<b>RREL</b> Reading was originally implausible but released on investigation as plausible
<b>REST</b> Reading was estimated and usage factors deriving from estimate will be used in Settlement. See Read Type for reason for estimate.
<b>RENS</b> Reading was estimate but usage factors are not updated and will not be used in settlement. This is generally because a full set of readings was estimated due to implausibility.
<b>Optional/Mandatory;</b> Although the following Data Items are optional, note the following caveats:-
Actual Usage Factor: Provided by the period terminating on the read date
Estimated Usage Factor: Provided for the period following the read date

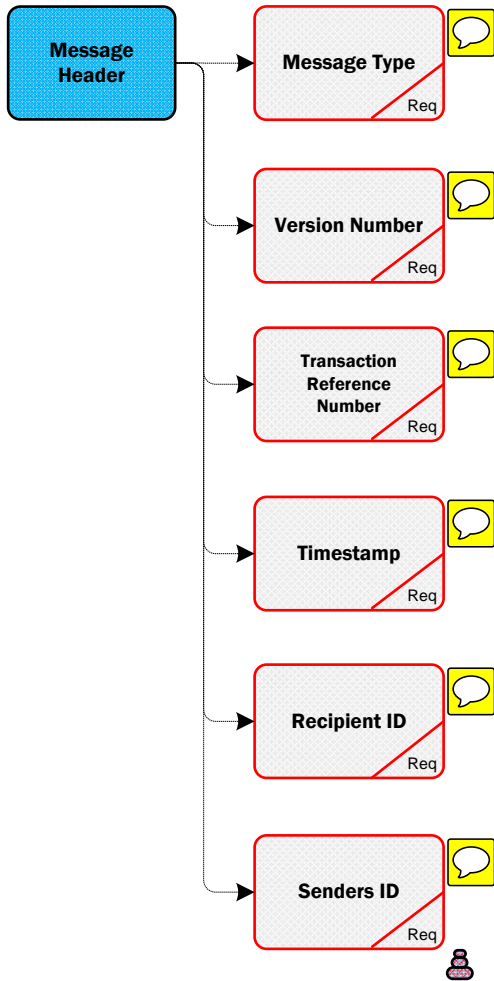

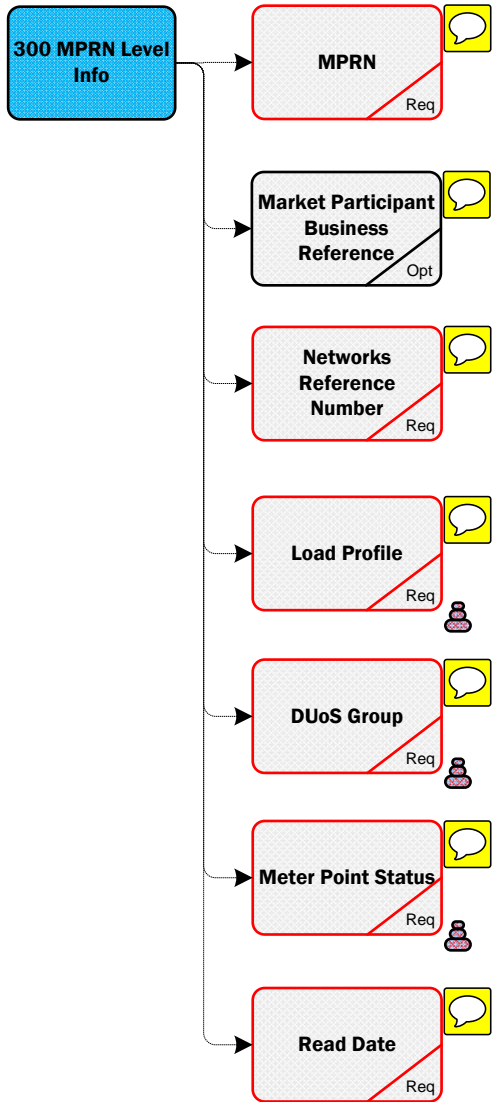



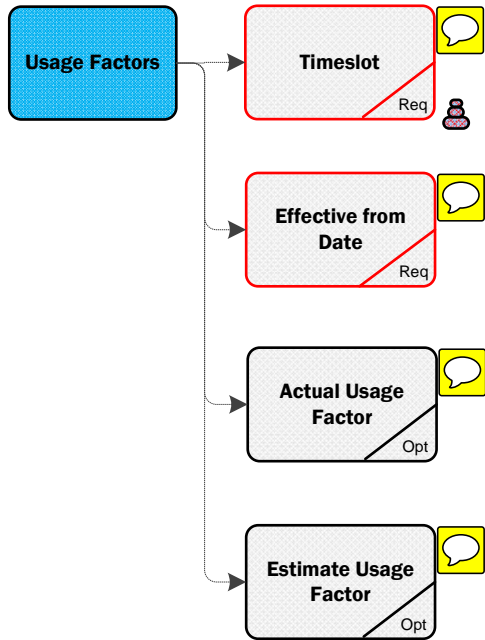

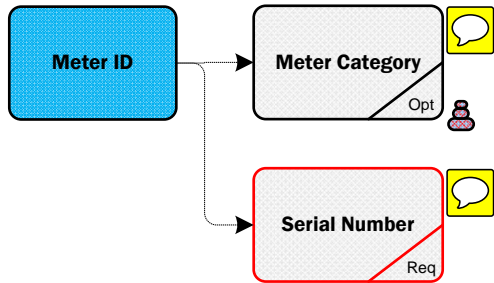



### Register Level Information

**Meter Registration Sequence**  
Req 

**Timeslot**  
Req   



**Unit of Measurement**  
Req   

**Meter Multiplier**  
Req 

**Reading**  
Req 

**Read Reason**  
Req   

**Read Type**  
Req   

**Register Type**  
Req   

**Previous Read Date**  
Req 

**Consumption**  
Opt 

**Read Status**  
Req   

**Senders  
ID**

**Click Here for Latest  
Senders ID  
List**



# 300 Validated Non Interval Readings Scheduled

Code

Load Profile

01 - Urban Domestic Unrestricted

10 - Unmetered - Flat

02 - Urban Domestic Day/Night

11 - Public Lighting Dusk/Dawn

03 - Rural Domestic Unrestricted

12 - Public Lighting Dusk/Midnight

04 - Rural Domestic Day/Night

05 - Non Domestic Unrestricted

06 - Non Domestic Day/Night

07 - MD with LF up to (but not including) 30%

08 - MD with LF greater than or equal to 30% but less than 50%

09 - MD with LF greater than or equal to 50%

Message

MPRN Level Information

**RMDS** RETAIL MARKET DESIGN SERVICE

Load Profile

# 300 Validated Non Interval Readings Scheduled

Code

DUoS Group

AGU	DG1	Urban Domestic	DG7	MV MD
AMM	DG10	Yes	DG7A	MV MD Autoproducer
CAN	DG2	Rural Domestic	DG7B	MV MD Importing Autoproducer or CHP Producer
CIP	DG3	Public Lighting	DG8	38 kV Looped MD
COL	DG4	Unmetered Supplies	DG8A	38 kV Looped MD Autoproducer
COS	DG5	LV Non-Domestic Non-MD	DG8B	38 kV Looped MD Importing Autoproducer or CHP Producer
CUG	DG5A	LV Non-Domestic Non-MD Autoproducer	DG9	38 kV Tailed MD
DIJ	DG5B	LV Non-Domestic Non-MD Importing Autoproducer or CHP Producer	DG9A	38 kV Tailed MD Autoproducer
DSO	DG6	LV MD	DG9B	38 kV Tailed MD Importing Autoproducer or CHP Producer
IA	DG6A	LV MD Autoproducer	DG10	110kV Distribution
ICD	DG6B	LV MD Importing Autoproducer or CHP Producer	TCON	Transmission Connected

Message

MPRN Level Information

**RMDS** RETAIL MARKET DESIGN SERVICE

DUoS Group

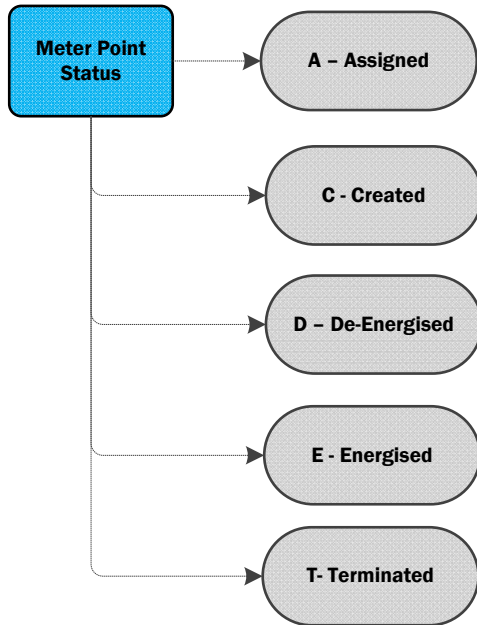

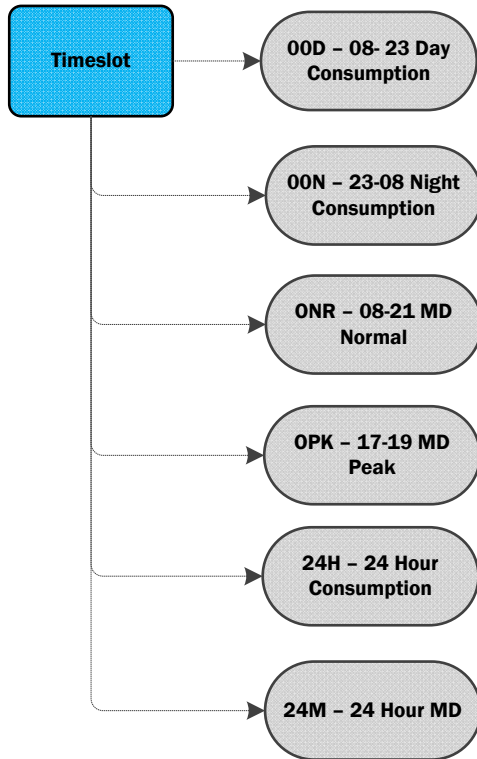



**Meter Category**

**Click Here for Latest  
Meter Category  
List**

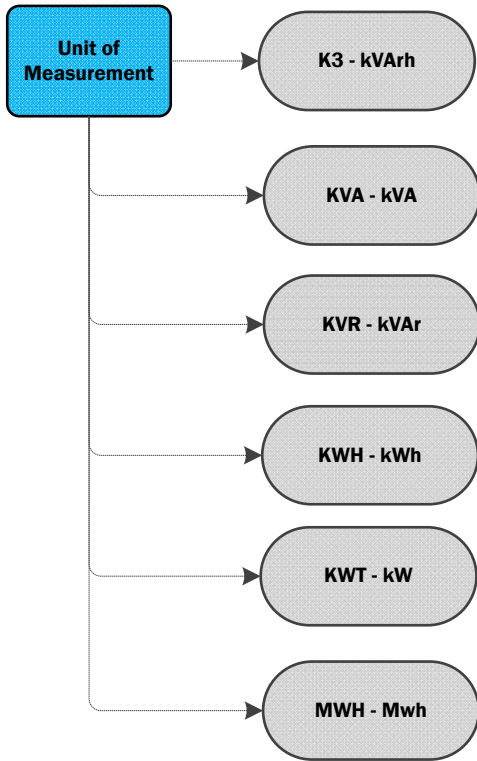

# 300 Validated Non Interval Readings Scheduled

Code

Read Reason

01 - Scheduled

17 - Change of Profile

95 - Not for CoS

02 - Special Read, Chargeable

18 - Energisation

04 - Special Read to resolve dispute

21 - Start Reading ( New Register)

09 - Special Read, non chargeable

22 - Closing Reading (Register removed)

10 - Ad-hoc, no chargeable check read

23 - Meter Works Single reading

11 - Start reading after meter re-programming

26 - Change of Supplier

13 - De-Energisation

27 - Change of Legal Entity

14 - Estimate

28 - Closing read before register re-number

16 - Closing read before meter re-programming

29 - Star read after register re-number

Message

Register Level Info

**RMDS** RETAIL MARKET DESIGN SERVICE

Read Reason

# 300 Validated Non Interval Readings Scheduled

Code

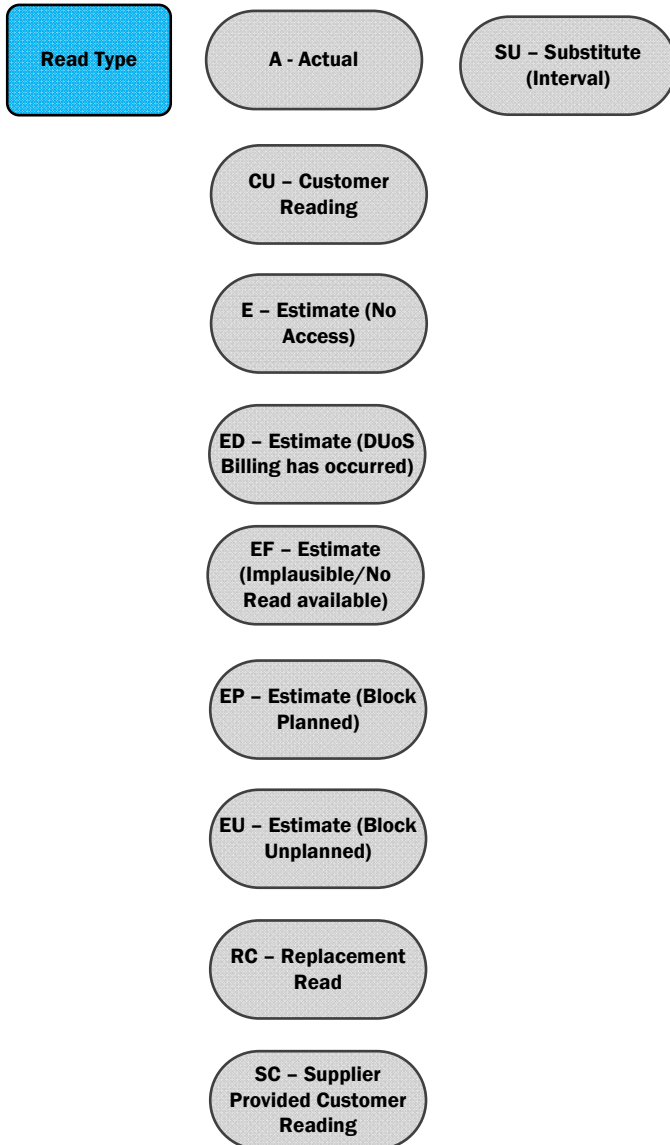

Message

Register Level Info

**RMDS** RETAIL MARKET DESIGN SERVICE

Read Type



# 300 Validated Non Interval Readings Scheduled

Code

Register Type

01 - 24hr

50 - IMP QH (KW)

02 - Day

51 - IMP QH (kVAr)

03 - Night

52 - EXP QH(KW)

04 - NSH

53 - EXP QH (kVAr)

05 - Wattless

06 - MD Normal

07 - MD Peak

08 - Cumulative MD  
Normal

09 - Cumulative MD  
Peak

Message

Register Level Info

**RMDS** RETAIL MARKET DESIGN SERVICE

Register Type

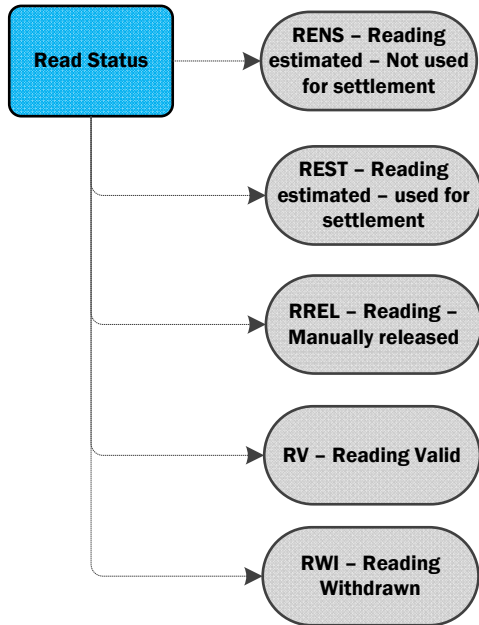

# 300 Validated Non Interval Readings Scheduled

Version Which Implemented	Source of Change	Description of Change
10.4	MCR 1155	Message format changed from ARIS to Document format.
10.6	CoBLCR 008 & CoBLCR 011	Meter Category - Removed table & replaced with link to Meter Category page on RMDS Website